

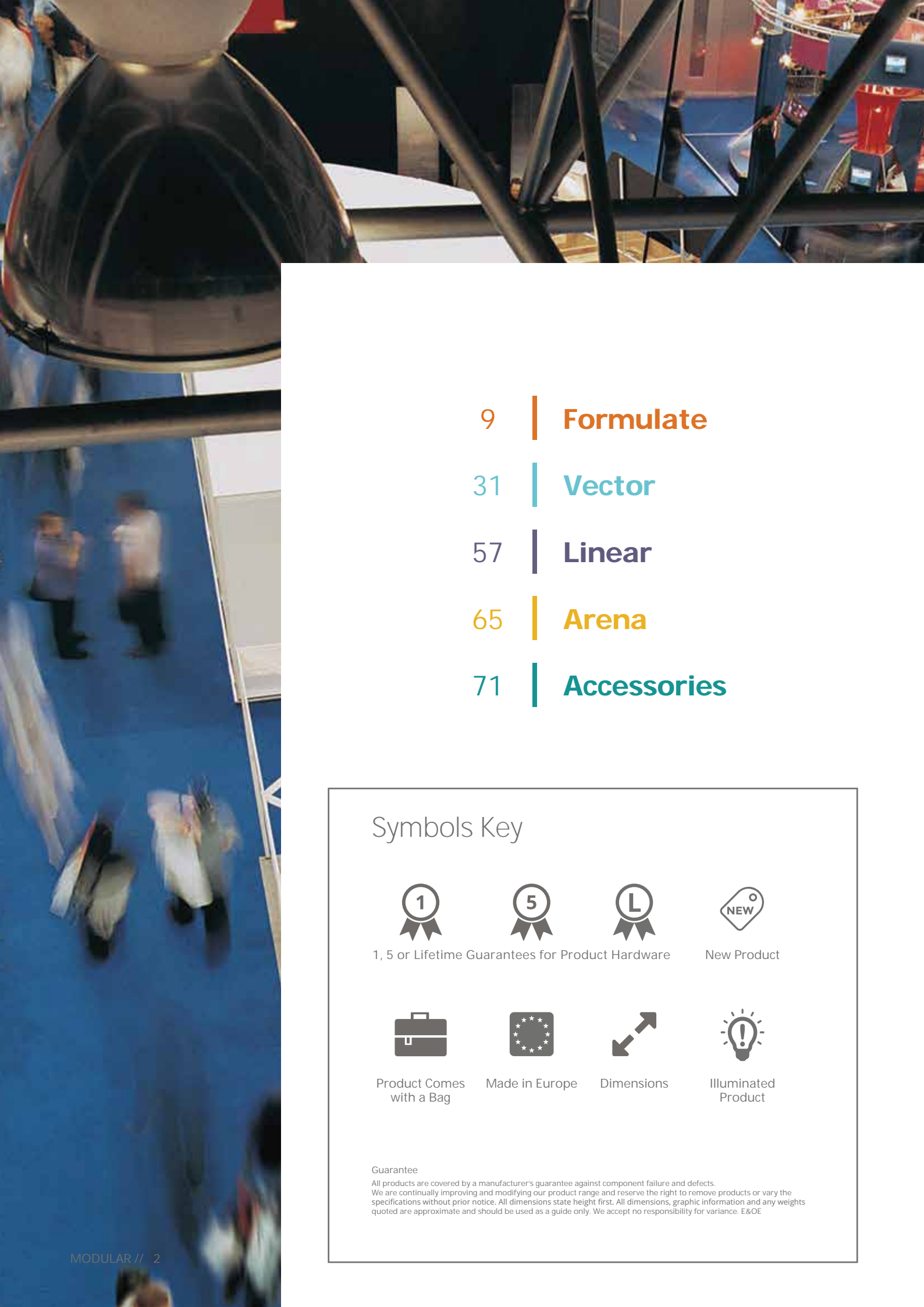

# MODULAR

Creative stand solutions for unique brands



9 | **Formulate**

31 | **Vector**

57 | **Linear**

65 | **Arena**

71 | **Accessories**

## Symbols Key



1, 5 or Lifetime Guarantees for Product Hardware



New Product



Product Comes with a Bag



Made in Europe



Dimensions



Illuminated Product

### Guarantee

All products are covered by a manufacturer's guarantee against component failure and defects. We are continually improving and modifying our product range and reserve the right to remove products or vary the specifications without prior notice. All dimensions state height first. All dimensions, graphic information and any weights quoted are approximate and should be used as a guide only. We accept no responsibility for variance. E&OE



## To Modulate:

Dictionary definition

*To adapt something flexibly to match various circumstances*

# MODULAR

No matter what sort of space you are dealing with, or what your communications objectives are, we have a Modular solution that will meet your requirements. Our Modular range provides the best of both worlds, a compromise between cost-effective, portable solutions and the traditional custom-built joinery stand.

Take a look at our comprehensive range, created by our own in-house design team and built by our experienced production teams. You can choose from four possible Modular solutions to complete your project, allowing the freedom to let your imagination run riot.

## Formulate

FORMULATE is a highly original concept, combining a unique mastery of the space using tubular structures and adding the infinite possibilities of printed fabrics for graphics. Aluminium tubes are used to create innovative shapes and structures that add value to your communications, these can be made to custom designs that meet your exact needs.

## Vector

VECTOR is one of the most simple and versatile visual communication solutions on the market. It comprises an aluminium frame with a stretched textile or rigid graphic and can be adapted to any kind of location. There are many different styles, enabling all kinds of applications: wall-mounted, free-standing, double sided and with lighting.

## Linear

LINEAR is an excellent choice for all Point-of-Sale communications and stands where you want to add value to flexible or rigid PVC graphics. You can choose between visible or hidden frames, depending on your requirements and preferences.

## Arena

ARENA is an attractive tubular aluminium display structure which is both extremely lightweight and robust. Various sections can be assembled according to the space available and can then be covered with visual displays on fabric or flexible PVC.

### Our Product Range

We are dedicated to delivering the widest choice of products from cost effective, to premium quality. We promise to continuously search for new and pioneering ideas bringing innovation and excitement to our complete range of portable display products. Our products cover a broad range of needs from simple cost effective display solutions to more comprehensive and specialist displays for both one off and semi-permanent use.

### Design and Patent

Some of the products in our catalogue carry a Worldwide Patent, some carry a Design Patent. All of our unique products are designed in the UK / USA and designs are registered. Due to variations in graphic substrates, graphic thicknesses stated are provided as a guide only. Always check the suitability of your substrate on the display unit before application.



# Point of Sale communications

## The secrets of success in Point of Sale design and display

The design and display at your Point of Sale plays a vital role in the shop environment in differentiating your offering and attracting customers. Your display must serve to arouse the curiosity of potential clients, it should make them feel welcomed and valued, at the same time creating the ambience that will spark their interest.

**The window display is a key element**, in promoting the identity of the shop, encouraging the client to walk in and discover your products. Therefore drawing attention from outside the shop is important, using effective visual communications, including free-standing, suspended or even illuminated displays. These can be regularly refreshed to promote new seasons or products and continuously be updated.

**The decoration and layout of a shop interior** must create the ideal environment in which to discover products. Wall-mounted communications are the most cost-effective media because they allow floor space to be used for product displays. Illuminated wall displays located behind the cash registers, can help to reinforce messages you wish to convey.

The aluminium frames of the **Vector** range fitted with displays in stretch fabric perfectly meet these needs.





## Pop-up Stores: temporary is on trend

Now a part of everyday life, the temporary shop (or Pop-up Store), is THE current retail trend and very popular with the public. Whether it appears in a commercial shopping environment or in an area of strategic footfall, it gives the consumer the opportunity to experience your brand, albeit briefly, from a few days to a few months.

### Top tips for success

To create a successful pop-up store, it is essential to:

- Choose a strategic site;
- Select an original and flexible layout and location;
- Choose the time of year and how long to be there;
- Set up entertainment events;
- Organise upstream communications: target your campaign on the geographic zone chosen, to obtain optimal return; set up partnerships with other brands; send out preview invitations to influential bloggers and journalists...

### Using Modular solutions

Creating successful communications at a Point of Sale is dependent on a solution that combines both an original design and the best value for money.

**To ensure you make the right choice, it is important to consider your objectives and answer the following questions:**



#### - Location:

How much space is available to you?  
What are your potential constraints in terms of height and dimensions?



#### - Design:

Application: wall-mounted, suspended or free-standing?  
Types of materials: fabric, rigid or flexible panels?  
Is back-lighting a requirement?



#### - Use:

How often do you need to update your message?  
Must the visuals be changed by a professional or can this be done by the end user?



#### - Budget:

What budget is available for your modular solution?  
How many Points of Sale need to be fitted?

## Why choose a modular solution?

- + Cost effective
- + Design
- + Easy to assemble
- + Compact for easy transportation to several Points of Sale
- + Standard or bespoke
- + Unlimited refresh/update of messages



# Exhibition Communications

## Why exhibit at an event?

Businesses that are aiming to drive brand recognition and to promote their products and services often choose exhibitions to help them achieve this.

There are many great benefits of this approach as an exhibition allows exhibitors to carry out a number of activities in a relatively short time-scale:

- Finding new customers
- Monitoring the market
- Presenting new products
- Increasing customer loyalty
- Business networking

## Why choose a modular stand?

- + Lightweight and compact
- + Reconfigurable
- + Short payback
- + Durable
- + Easy to assemble
- + Standard or bespoke
- + Unlimited refresh/update of messages
- + Ergonomic design



## Your stand - the cornerstone of your exhibit

Creating a stand that reflects your brand image, but not at any price.

**The success of an exhibition is also dependent upon value for money. To make the best choices, you must list your objectives and answer the following questions:**



- Location:

What space is available to you? Number of open sides?



- Design :

Type of materials: fabric, rigid or flexible panels?

Can height be used for communications: use of banners, or allowing increased storage space?

What storage space for materials, brochures, is needed?

Is lighting needed to draw attention to your stand?



- Usage:

How often will the stand be used?

Does it need to be scalable (both shape and size)?

How can you transport it?



- Budget :

How much budget is available to build your stand?

How many exhibitions do you need to attend before costs are recouped?

Can the stand be reused in another setting: showroom layout, background display, etc.?

### Keys to success

Making your exhibition presence a success requires a number of things:

- Set **three to five** clear objectives, which will guide your Marketing Strategy during the event.
- Maximise the visual impact with a good quality stand promoting the company's image (open sides, suspended **displays, good graphics, quality materials** etc.).
- **Implement** effective communications and promotion strategies before, during and after the event including: emailing, invitations, social networking and promotional offers at the stand.

Whatever the space,  
Modular products  
will bring you a wide  
choice of solutions.



# MODULAR

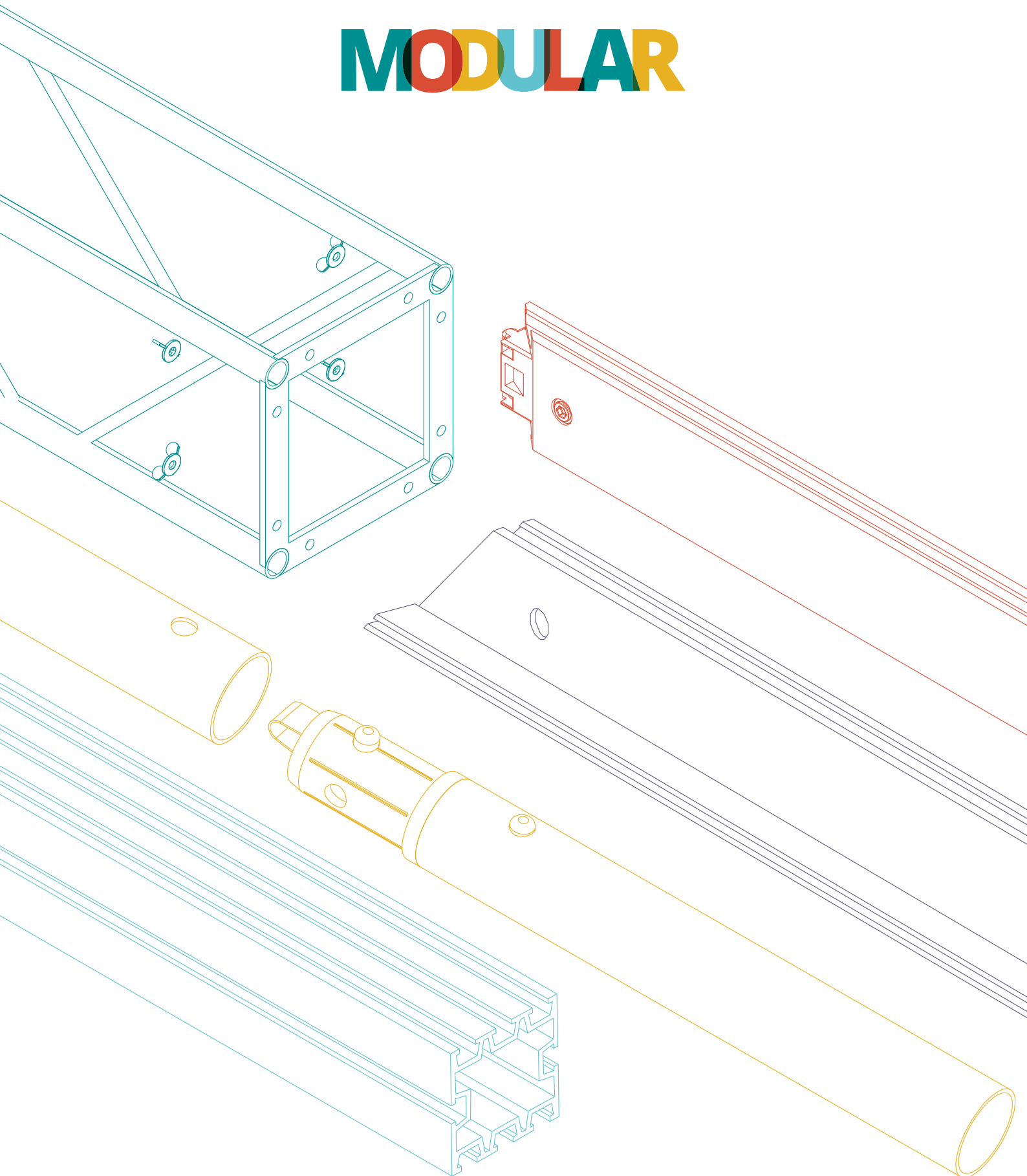





1. Circle Hanging Structure
2. DS3 Designer 10 Stand

# Formulate

Our Formulate range provides limitless branding opportunities. Our comprehensive range of Point of Sale and event stands are also complemented with hanging frames to prominently display brands and events in 3D.

By its very nature printing on fabric allows you to explore new possibilities in terms of both graphics and shapes. Graphic designs can be reproduced using dye sublimation processes, on stretchy material to allow a close fit to any shape, even the most unexpected ones! Installation is very simple and, because the displays are not very bulky, they are also very easy to transport.

# Original and innovative shapes that take centre stage

This simple and intuitive product is easy to construct in any environment. Formulate solutions are available in many configurations, including: totem poles, three to nine meter wide image walls, columns and arches; and they can also be made to measure.

The main purpose of Formulate is to give you a design solution that works where traditional wooden or aluminium angular structures have limitations. The aluminium tubes can be moulded and folded, to suit your needs. With Formulate you can let your creativity run wild.



## Assembly made simple

Formulate structures are made from 30 and 50 mm diameter anodised aluminium tubes.

Like a child's construction set, each section has a clear numbering system to facilitate easy assembly.

In addition to providing a solid structure, the various angled connectors of our Formulate system also allow you to create multiple configurations using different connector types and the angles they provide.

## 360° Visual Communications

Formulate is characterised by its fabric graphic with zip system. Therefore the display has no visible joins and is double-sided, optimising the impact of the message.

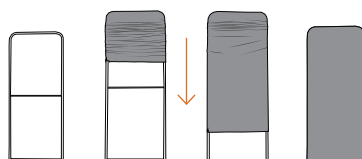

Simply slide the graphics over the frame to complete your product.

## // Custom designs - release your creativity

Custom-made solutions can be created to suit your specific needs. They offer exciting and innovative possibilities in terms of the shapes that can be created and the fabric graphics. They are designed to deliver maximum return on investment by displaying your brand in the most flexible and adaptable way for your needs.

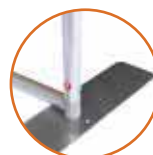

Free-standing, with or without feet, depending on the curve of the frame



Metal hooks for hanging structures



Attach to an existing structure



Simple marking and coding system

The use of numbered stickers makes assembling the various systems very easy to follow, like a child's construction set.

## // Assembling Formulate

### Assembling the Ø30mm sections

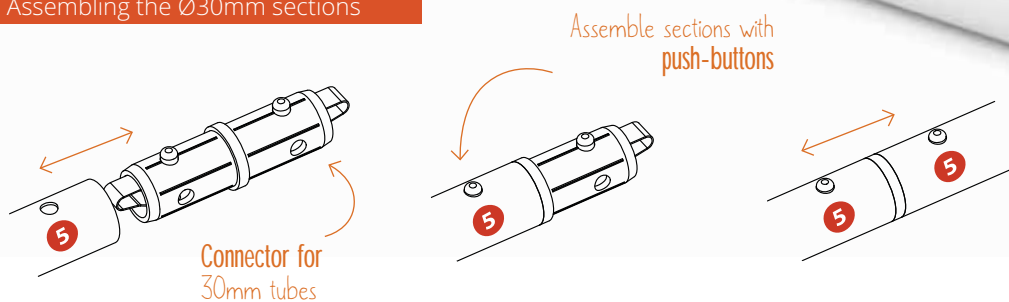

### Assembling the Ø50mm sections

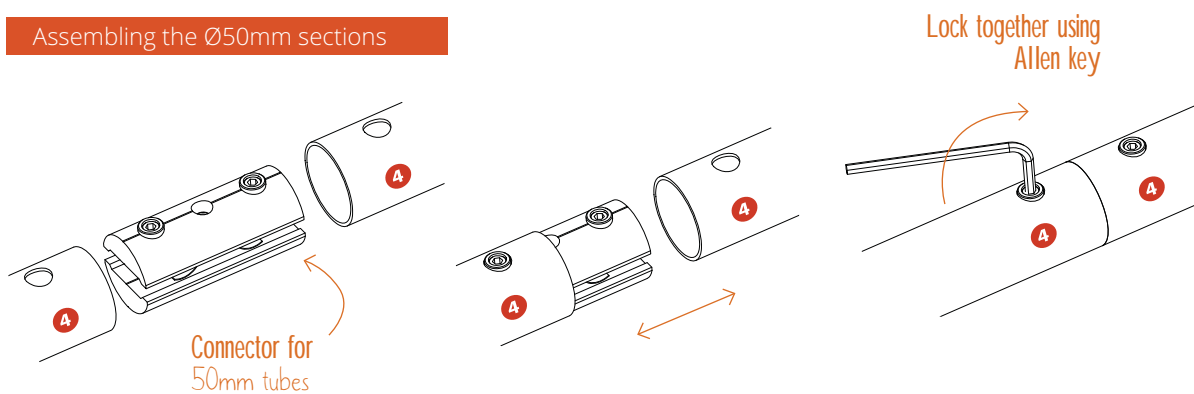

## // Different types of connectors for Ø30mm sections

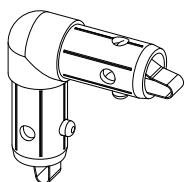

TC-30-90T  
90° connector

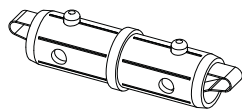

TC-30-S  
Straight connector

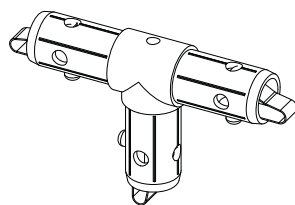

TC-30-T  
T-connector

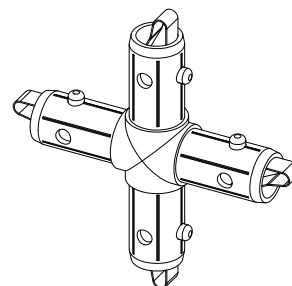

TC-30-X  
4-way cross connector



#### Tip:

All Formulate products come with cotton gloves to protect your graphics when being fitted to the frame.

# Formulate Tension banners

Nothing could be simpler to set up. For a 2D or 3D effect, single or double-sided printing. Formulate tension banners communicate on a large scale and adapt to all environments.

- Tubular aluminium structure Ø30mm
- Straight or curved sections
- Fabric graphic with zip system
- Customisable with double-sided print
- Easy installation without tools with coding system
- Ability to accessorise
- Carry bag included



Coding system



Stabilising feet



Ø30mm aluminium tubing

## MS Banner Straight



Model	Code	(h) x (w) x (d) mm
Straight 1000mm	FMLT-BS-10	2337 x 990 x 450 mm
Straight 1200mm	FMLT-BS-12	2337 x 1270 x 450 mm
Straight 1500mm	FMLT-BS-15	2337 x 1570 x 450 mm



## MS Banner Curved



Model	Code	(h) x (w) x (d) mm
Curved 900mm	FMLT-BC-10	2356 x 920 x 609 mm
Curved 1200mm	FMLT-BC-12	2356 x 1200 x 609 mm
Curved 1500mm	FMLT-BC-15	2356 x 1500 x 609 mm





# Formulate Backwalls

Simplicity, stability and originality perfectly describe Formulate Backwalls. Available in a variety of sizes and shapes, with enhanced branding communication opportunities from vibrant printed graphics.

- Tubular aluminium structure Ø30mm or Ø50 mm according to the format
- Available in different shapes
- Fabric graphic with zip system
- Customisable with double-sided print
- Simple installation with coding system
- Ability to accessorise



## Formulate Straight



Model	Code	(h) x (w) x (d) mm
2400mm	FORM-STR-24	2380 x 2350 x 400 mm
3000mm	FORM-STR-30	2380 x 2950 x 400 mm
6000mm	FORM-STR-60	2380 x 5950 x 400 mm

## Formulate Vertical Curve



Model	Code	(h) x (w) x (d) mm
Vertical Curve	FMLT-USS-01	2280 x 3048 x 583 mm

## Formulate Horizontal Curve



Model	Code	(h) x (w) x (d) mm
2400mm	FORM-CUR-24	2340 x 2350 x 500 mm
3000mm	FORM-CUR-30	2340 x 2950 x 500 mm
6000mm	FORM-CUR-60	2340 x 5950 x 600 mm

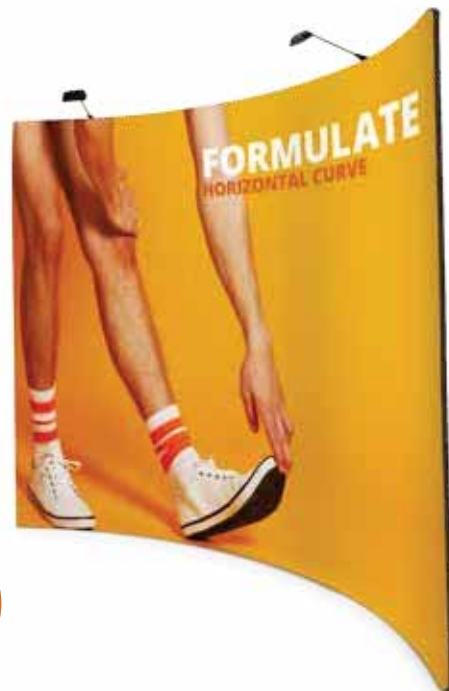

Can be accessorised with spot lights

Universal fitting kit required (US901-C)

Double-sided graphic



Easy matching system



Tubes are connected by bungee cord

## MS6 Vertical Curved



Model	Code	(h) x (w) x (d) mm
Vertical Curved	FMLT-WV60-01	2336 x 5891 x 609 mm



Add spotlights for greater stand illumination  
LED-FLOOD-ARM-BDLK



## MS6 Horizontal Curved



Model	Code	(h) x (w) x (d) mm
Horizontal Curved	FMLT-WH60-01	2336 x 5756 x 975 mm

Stabilising feet regularly placed for increased stability



## MS6 Straight



Model	Code	(h) x (w) x (d) mm
Straight	FMLT-WS60-01	2336 x 5838 x 450 mm

lightweight 50mm diameter tubes



## MS6 Serpentine Curved



Model	Code	(h) x (w) x (d) mm
Serpentine	FMLT-WSC60-01	2337 x 5740 x 824 mm

## DS9 Designer 01



Model	Code	(h) x (w) x (d) mm
Straight 9m	FMLT-DS-90-01	2336 x 8890 x 650 mm



## DS9 Designer 03



Model	Code	(h) x (w) x (d) mm
Horizontal Curved 9m	FMLT-DS-90-03	2336 x 8890 x 910 mm



Large self-supporting backwall



## DS9 Designer 06



Model	Code	(h) x (w) x (d) mm
Serpentine 9m	FMLT-DS-90-06	2336 x 9000 x 830 mm



Elegant shape



# Formulate Stands

Formulate stands are structures of original and modern shapes. Their unique style creates great branding communication.

Manufacturing Formulate tubular structures requires comprehensive production techniques; cutting, welding, and bending for example. Formulate printed fabric graphics offer many unique possibilities for branding and personalisation.

- Tubular aluminium structure Ø30mm or Ø50 mm diameter
- Fabric graphic with zip system
- Customisable with double-sided print
- Simple installation with coding system



## DS3 Designer 03



Model	Code	↗ (h) x (w) x (d) mm
Stand DS3 03	FMLT-DS-30-03	2498 x 3100 x 565 mm



\* Screen not included

Broadcast your message with optional extra screen\* mount

## DS3 Designer 01



Model	Code	↗ (h) x (w) x (d) mm
Stand DS3 01*	FMLT-DS-30-01	2472 x 2936 x 1129 mm



Illuminate your brand with optional extra LED spotlights  
LED-FLOOD-ARM-BDLK

Three walls can create one versatile large backwall

## DS3 Designer 02



Model	Code	↗ (h) x (w) x (d) mm
Stand DS3 02	FMLT-DS-30-02	2463 x 3206 x 848 mm





## DS3 Designer 10



Model	Code	(h) x (w) x (d) mm
Stand DS3 10*	FMLT-DS-30-10	2510 x 2910 x 472 mm



\* Screen not included

Add backwalls to draw attention to your screen!



\* Screen not included

## DS3 Designer 07



Model	Code	(h) x (w) x (d) mm
Stand DS3 07*	FMLT-DS-30-07	2499 x 2797 x 495 mm

Concave and convex shapes perfect together

## DS3 Designer 05



Model	Code	(h) x (w) x (d) mm
Stand DS3 05	FMLT-DS-30-05	2490 x 3440 x 540 mm



Frame your stand and add brand communication with printed profile arches



### DS6 Designer 07



Model	Code	↗ (h) x (w) x (d) mm
Stand DS6 07*	FMLT-DS-60-07	2443 x 5614 x 508 mm



### DS6 Designer 03



Model	Code	↗ (h) x (w) x (d) mm
Stand DS6 03*	FMLT-DS-60-03	2532 x 5838 x 1000 mm



### DS6 Designer 08



Model	Code	↗ (h) x (w) x (d) mm
Stand DS6 08*	FMLT-DS-60-08	2405 x 6070 x 450 mm



### DS9 Designer 05



Model	Code	↗ (h) x (w) x (d) mm
Stand DS9 05	FMLT-DS-90-05	2494 x 8627 x 472 mm

Expandable backwall from three separate structures



Use the optional extra universal mounting system US901-C and add LED spotlights to your Formulate structures

# Formulate Columns

Formulate columns are impressive towers that are easy to arrange and decorate interior spaces. Available in several heights, these columns are ideal for highlighting a message. Used as a signalling point, as a signboard or for decorating, Formulate columns can easily be placed on a stand or in an exhibition hall.

The printed fabric graphic makes it possible to add branding and communicate your message on all four sides of the structure.

- Tubular aluminium structure Ø30mm
- Fabric graphic with zip system
- Customisable on all four sides with print
- Light and stable at the same time.
- Simple assembly without tools using just the coding system



## AS Tower S



Model	Code	(h) x (w) x (d) mm
Tower S	FMLT-COL25	2500 x 1000 x 1000 mm

Make your message up to 3.5 m high!



## AS Tower L



Model	Code	(h) x (w) x (d) mm
Tower L	FMLT-COL35	3500 x 1000 x 1000 mm



## AS Tower M



Model	Code	(h) x (w) x (d) mm
Tower M	FMLT-COL30	3000 x 1000 x 1000 mm

# Formulate Meeting Areas

Creating private reception areas or arranging meeting areas at a trade show or event is now possible thanks to the Formulate Conference Walls.

Perfect-fit printed fabric graphics highlight the original shapes of these structures.

- Tubular aluminium structure Ø30mm or Ø50 mm according to the format
- Fabric graphic with zip system
- Customisable with double-sided print
- Simple installation with coding system

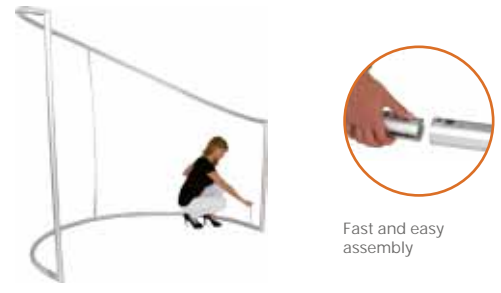

Fast and easy assembly

Large visual branding and communication area



Guaranteed impact and maximum visibility

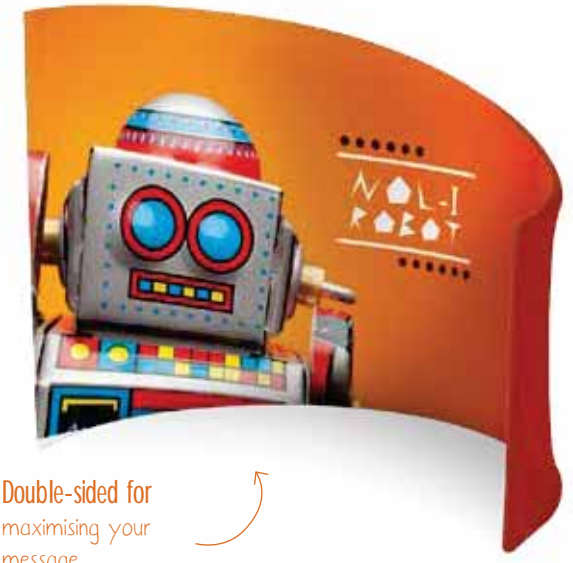
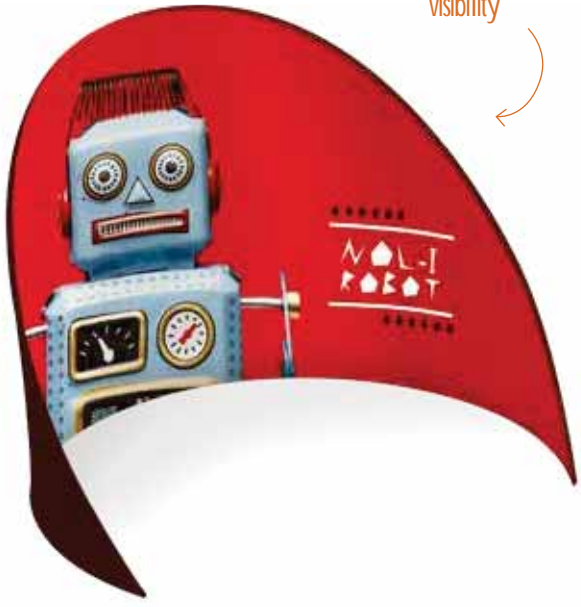

Double-sided for maximising your message

## AS Chip Wall



Model	Code	↗ (h) x (w) x (d) mm
Chip Wall	FMLT-CC-01	1915 x 2823 x 2099 mm

## AS Shaped Wall



Model	Code	↗ (h) x (w) x (d) mm
Shaped Wall	FMLT-CW-01	2137 x 2283 x 1522 mm



# Formulate Arches

Formulate arches are a great way to stand out. Their original and innovative shapes make them identifiable even from a distance and can easily attract the attention of passers-by.

Formulate arches perfectly combine the possibilities of tubular structures and the printed fabric graphics. They can optimise a space in an aesthetic way and create a visual effect that plunges the visitor into the universe of the advertiser.

- Tubular aluminium structure Ø50mm
- Fabric graphic with zip system
- Customisable with double-sided print

Self-supporting structure



Ø50mm aluminium tubing



Fast and easy assembly



Maximise communication possibilities with two optional extra screens mounts

## AS Arch 03



Model	Code	(h) x (w) x (d) mm
Arch 03*	FMLT-ARCH40-03	3456 x 5839 x 2454 mm



## AS Arch 01



Model	Code	(h) x (w) x (d) mm
Arch 01*	FMLT-ARCH40-01	2427 x 3475 x 2337 mm

\* Screen not included

# Formulate Hanging Structures

Formulate hanging structures have been specially designed for simple and safe installation. The lightweight aluminium tubular structures make them ideal for dressing up an exhibition stand, shopping mall or indoor venue. The printed fabric graphic ensures optimum visibility.

- Tubular structure made of aluminium 30mm or 50mm diameter
- Fabric graphic with zip system
- Customisable with double-sided print
- Simple installation with coding system

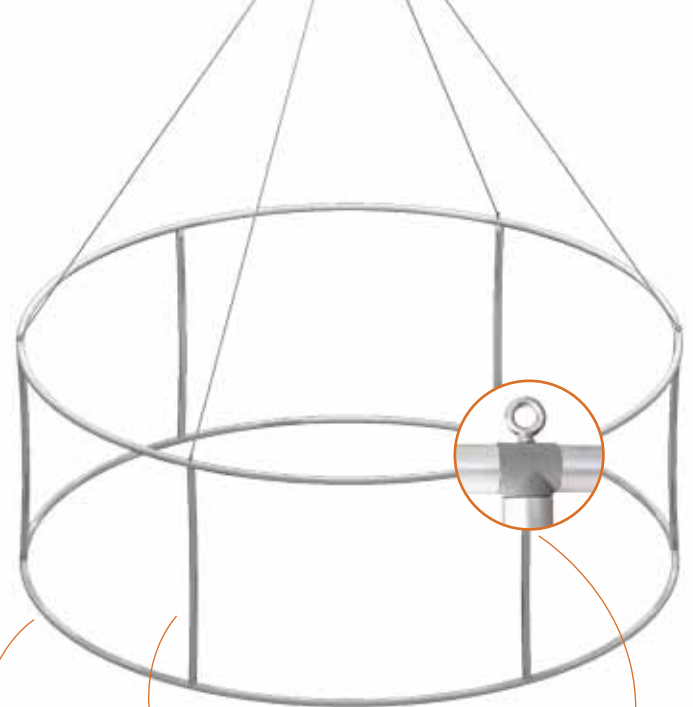

Tubular structure in anodised aluminium, strong yet lightweight

The mounting and coding system makes assembly of hanging structures fast and simple

Each structure has metal hooks attached



## Circle Hanging Structure



Model	Code	(h) x (dia) mm
Circle 1.5m diameter	FMHS-RIN-01	762 x 1524 mm
Circle 3m diameter	FMHS-RIN-02	610 x 3048 mm
Circle 3m diameter	FMHS-RIN-03	914 x 3048 mm
Circle 4.6m diameter	FMHS-RIN-04	1524 x 4572 mm
Circle 6m diameter	FMHS-RIN-05	1219 x 6096 mm



## Print finishing possibilities

Fabric graphics are printed by dye-sublimation, which ensures a high quality finish and amazing colours.



## Rectangle Hanging Structure



Model	Code	(h) x (w) x (d) mm
Rectangle	FMHS-REC-01	1219 x 3658 x 2438 mm



## MS Panel



Model	Code	(h) x (w) x (d) mm
Panel 250	FMH-FLT-M100	1000 x 2500 x 30 mm
Panel 350	FMH-FLT-L100	1000 x 3500 x 50 mm
Panel 500	FMH-FLT-XL120	1200 x 5000 x 50 mm



Double-sided graphics

## MS S-Curve



Model	Code	(h) x (w) x (d) mm
Curve 350	FMH-SSB-L100	1000 x 3500 x 30 mm
Curve 500	FMH-SSB-XL120	1200 x 5000 x 50 mm



## Square Hanging Structure



Model	Code	(h) x (w) x (d) mm
Square 2.4m	FMHS-SQU-01	1067 x 2438 x 2438 mm
Square 3m	FMHS-SQU-02	1219 x 3048 x 3048 mm

Also available  
in custom sizes



## MS Rounded Square



Model	Code	(h) x (w) x (d) mm
Rounded Square 250	FMH-RSQ-M100	1000 x 2500 x 2500 mm
Rounded Square 350	FMH-RSQ-L100	1000 x 3500 x 3500 mm
Rounded Square 500	FMH-RSQ-XL120	1200 x 5000 x 5000 mm



Branding on three sides!

### MS Pinwheel



Model	Code	(h) x (w) x (d) mm
Pinwheel 250	FMH-PIN-M100	1000 x 2500 x 2500 mm
Pinwheel 350	FMH-PIN-L100	1000 x 3500 x 3500 mm

### Eye Hanging Structure



Model	Code	(h) x (w) x (d) mm
Eye 3m	FMHS-EYE-02	1219 x 3048 x 838mm
Eye 3.7m	FMHS-EYE-03	1524 x 3658 x 991mm



Brand the inside as well as the outside



Also available in custom sizes

### MS Hexagon



Model	Code	(h) x (w) x (d) mm
Hexagon 350	FMH-HEX-L100	1000 x 3500 x 3500 mm
Hexagon 500	FMH-HEX-XL120	1200 x 5000 x 5000 mm



## DS Tiered Ring



Model	Code	(h) x (w) x (d) mm
Tiered Ring 100	FMH-TRNG-L100	300 x 1500 x 1500 mm
		300 x 2500 x 2500 mm
		300 x 3500 x 3500 mm
Tiered Ring 120	FMH-TRNG-XL120	300 x 3000 x 3000 mm
		300 x 4000 x 4000 mm
		300 x 5000 x 5000 mm



Personalise the interior as well as the exterior



Maximise branding and communication potential with an impressive hanging structure that will command the view wherever displayed

## DS Tiered Square



Model	Code	(h) x (w) x (d) mm
Tiered Square 100	FMH-TSQU-L100	300 x 1500 x 1500 mm
		300 x 2500 x 2500 mm
		300 x 3500 x 3500 mm
Tiered Square 120	FMH-TSQU-XL120	300 x 3000 x 3000 mm
		300 x 4000 x 4000 mm
		300 x 5000 x 5000 mm

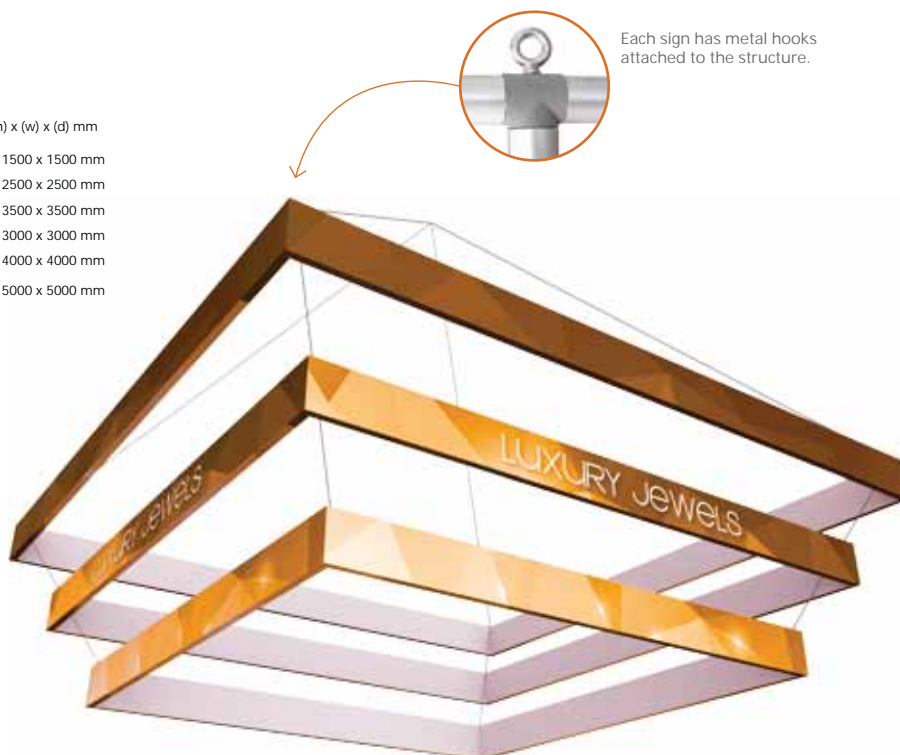

Each sign has metal hooks attached to the structure.

# Formulate Accents

Improving the functionality of Formulate structures and optimising the stand space is possible thanks to the different Formulate Accents elements.

Accents are made to complement Formulate structures and give more impact and visibility to brand messages.

- Tubular aluminium structure Ø30mm
- Fabric graphic with zip system
- Customisable with double-sided print
- Simple installation with coding system

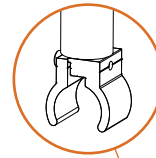

Add the individual Accents elements to create your own configuration



Multiple layouts!



## Accent 04 Round Half Wall



Model	Code	↗ (h) x (w) x (d) mm
Round Half Wall	FMLT-WBWA-04-C	900 x 1000 x 2500 mm



## Accent 05 Rounded Arch



Model	Code	↗ (h) x (w) x (d) mm
Rounded Arch	FMLT-WBWA-05	2500 x 1200 x 2400 mm



Direct customers to stands and still preserve the impact of backwall branding with a half wall

## Accent 04 Half Wall



Model	Code	↗ (h) x (w) x (d) mm
Half Wall	FMLT-WBWA-04-S	900 x 1500 x 2500 mm

Enhance branding



### Accent 17 Advanced Trapeze



Model	Code	(h) x (w) x (d) mm
Advanced Trapeze	FMLT-WL17	2516 x 1700 x 154,6 mm

### Accent 06 Arch with Curved Roof



Model	Code	(h) x (w) x (d) mm
Arch with Curved Roof	FMLT-WBWA-06	2800 x 1200 x 2400 mm

### Accent 14 Large Advance



Model	Code	(h) x (w) x (d) mm
Large Advanced	FMLT-WL14	2438 x 1219 x 494 mm

### Accent 15 Small Advance



Model	Code	(h) x (w) x (d) mm
Small Advanced	FMLT-WL15	2453 x 450 x 494 mm







# Custom-made

Custom-made creations offer incredible possibilities in terms of graphic shapes and visual effect. They optimise return on investment by maximising brand communication in a more suited shape and format.



## The best way to stand out

The use of larger formats is a great way to draw attention to a stand. The quality of Formulate can add to that impression and highlight the printed graphic and overall design as well as the unique shape of the stand.



Guarantee originality with uniquely shaped lightweight tubular structures and vibrant printed graphic fabrics





## Original shapes that adapt to all environments

The possibility of curving and cutting tubular structures, combined with the use of stretch fabric, creates custom made solutions for stands or items of furniture with infinite possibilities.



Even twisted structures are possible

The possibilities offered by Formulate structures are unique. They enhance the message of brands thanks to the use of large-format visuals that perfectly match the contours of structures with ergonomic and innovative shapes.

What can we create for you?

Create added perspective with multiple-angled structures



# Accessories

Making Formulate structures more attractive and multi-functional is easy with various accessories such as screens, shelves, literature holders ... A new accessory system has been designed to give you the freedom to add and change items whenever you need them.

With a single clamp attachment, you can add a multitude of accessories to your Formulate structures



## Universal Accessory Clamp

Model	Code
Clamp 30mm	FMLT158



Great stability

## Literature Holders



Model	Code	(h) x (w) x (d) mm
Literature Holder Support	FX839	
Literature Holder DL	AH5DLP	Format DL (11x22cm)
Literature Holder A5	AH5A5P	Format A5
Literature Holder A4	AH5A4P	Format A4

## iPad Holder



Model	Code	(h) x (w) x (d) mm
iPad/Screen Support	FX837	
iPad Holder White	IPAD-CHU-W	305 x 70 x 40 mm
iPad Holder Silver	IPAD-CHU-S	305 x 70 x 40 mm
iPad Holder Black	IPAD-CHU-B	305 x 70 x 40 mm

iPad Holders is compatible with all iPads except iPad mini and Pro. iPad not included and not available to purchase

## Shelves



Model	Code	(h) x (w) x (d) mm
Shelving Support	FX838	
Round shelf	LN133-R	12 x 240 x 227 mm
Triangle shelf	LN133-T	12 x 254 x 246 mm
Square shelf	LN133-S	12 x 220 x 220 mm

Shelving available in four colors: ● ● ● ●

## NEW Screen Stand



Model	Code	(h) x (w) x (d) mm
Screen stand	LN136	1800 x 901 x 859 mm



## Large Carry Bag



Model	Code	(h) x (w) x (d) mm
Large Carry Bag	WF-BG-S	470 x 1700 x 400 mm

Quickly identify your structure using the card holder



## Carry Bag



Model	Code	(h) x (w) x (d) mm
Carry Bag	TUBE-BAG	300 x 1370 x 150 mm



1. Vector Quick Fix
2. Vector 75mm LED

# Vector

The Vector aluminium frame system with stretched canvas display adapts perfectly to changing needs, tastes and projects, making it the simplest and most flexible system on the market.



Intuitive tracking system on each section

## Vector – The art of communicating

As a display wall, free-standing display or backlit solution, the wide selection of widths offered by the Vector aluminium frames provides a range of solutions for every requirement and every budget. You will benefit from the strongest visual impact and creative designs, which can be adapted for any location: showrooms, Point of Sale, exhibitions, museums and many others.

### // Anodised aluminium profiles

Our Vector range has eight styles of aluminium frame which are perfectly suited for a wide range of applications. Our summary table will help you choose the right one for you.

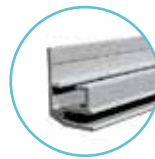

Quick Fix 20 mm

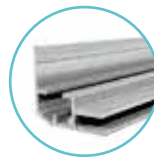

30 mm



50 mm - Fabric



50 mm - Rigid

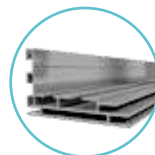

75 mm LED

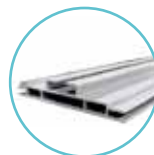

100 mm LED

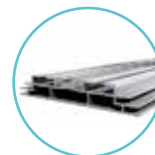

125 mm LED

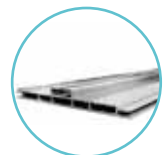

150 mm LED

Code	VECTOR	Wall Mounted	Free-standing	LED Illumination	Unlit	Double-sided	Economy	Premium
VWQF-CUSTOM	20 mm	x			x		x	
VLB30-CUSTOM	30mm	x			x		x	
VKF-CUSTOM	50mm	x	x		x	x		x
VLB75-CUSTOM*	75mm LED	x		x	x			x
VLB100-CUSTOM*	100mm LED		x	x	x	x	x	
VLB125-CUSTOM*	125mm LED		x	x	x	x		x
VLB150-CUSTOM	150mm LED		x	x	x	x		x

\* Available in standard modules for stand application



## // Assembling Vector

Two different types of connectors depending on the profile

**A** The push-button connector offers a faster mounting for the 50mm profiles.

**B** For other profiles, the screw fixing bracket provides an economical solution.



Straight Connector IB2

Corner connector CB9



Square LN298

Square LN297

Square VLF-01

Square LN156

Square LN164

Connector LN296

Connector LN295

Connector VLF-02

Connector LN157

Connector LN163

### Easy assembly of profiles and frames

The Vector range is characterised by its simplicity of assembly, a single multi tool Allen key is sufficient to assemble the different frames.

### Mounting a vector frame 50mm

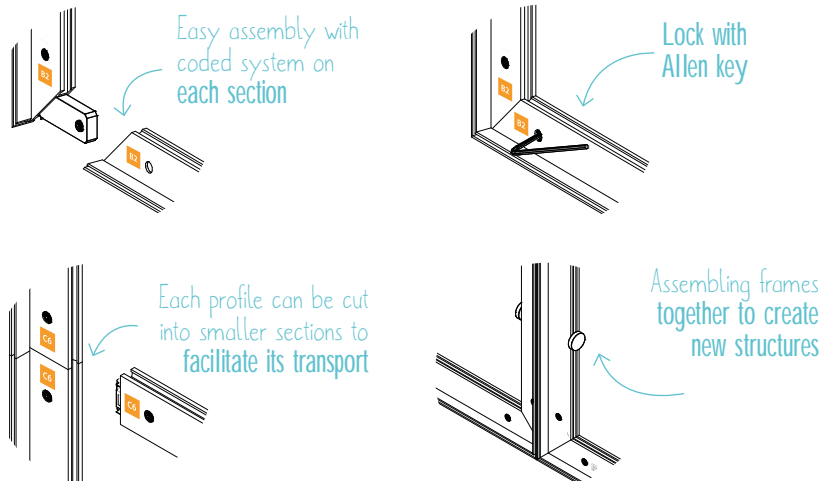

## // Strengthening crossbeams and tubes

Depending on the format and environment in which your display is to be installed, its structure may need strengthening. As a minimum, we recommend the use of reinforcing tubes for backlit assemblies.



Beam 45 mm



30 mm tube for LED frame

### Perfect tensioned graphics

The textile graphics have a silicone gasket that makes their installation simple and fast. Begin by inserting the SEG at each corner and position the display from the centre to the corners.

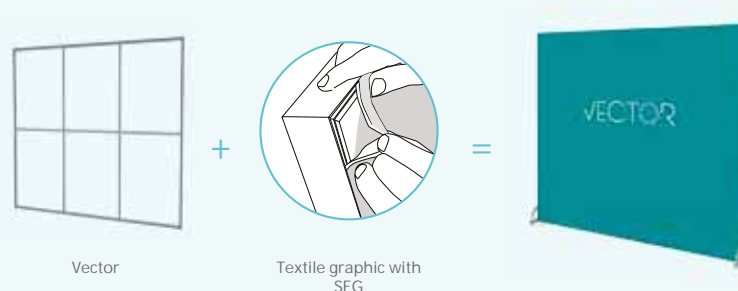

Vector

Textile graphic with SEG

# 20mm Quick Fix Profile

The Vector Quick Fix is the latest innovation in an extra-thin aluminium profile for stretch fabric graphics. Thanks to its versatile design this is a must for in-store communication and retail environments.



Assemble angled sections with screw-in bracket



20mm Aluminium profile

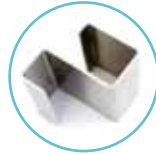

Optional shell scheme mounting bracket LN134

## 20mm Quick Fix Profile



- One profile, two applications: wall frames or shell scheme cladding
- Elegant and discreet thanks to its bevelled shape and its thickness of 20mm
- Rear profile for direct mounting to walls
- The assembly of the frame and the installation of the graphics are accessible to all

Ideal for decoration



Model	Code	(h) x (w) x (d) mm
20 mm Vector	VWQF-CUSTOM	Custom-made



Sleek aluminium frame



A practical and economical way to decorate your stands



### Technical information

- Anodised aluminium 6063 T6
- Dimensions : 20 x 27 mm
- Weight per ml: 0.317 kg
- Strengtheners required for wall application
- Simple assembly
- Textile SEG graphic

# 30mm Profile

Attract attention with our new 30mm wall system. The concealed frame creates amazing visual impact for brand communication.



Assemble angled sections with screw-in bracket

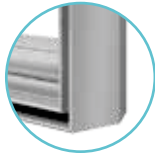

30mm Aluminium profile

## 30mm Profile



- Wall mounted textile frame
- Rear profile for fixing directly to walls
- Ideal for small format

Model	Code	(h) x (w) x (d) mm
30 mm Vector	VLB30-CUSTOM	Custom-made



Very small footprint

Ideal for interior decoration



An ideal solution for interior decoration or store signage

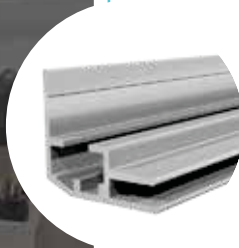

### Technical information

- Anodised aluminium 6063 T6
- Dimensions : 30 x 27 mm
- Weight per ml: 0.362kg
- Simple assembly
- Textile SEG graphic

# Print & Finishing

We understand that when planning an event or exhibition your time is precious with potentially multiple suppliers to manage.

With our single source supply solution, leading industry expertise and incredible customer service, why not trust us to deliver both your product and printing requirements as a complete solution.

Our state of the art printing capabilities and expert sewing and finishing teams can save you time allowing you to concentrate on the finer details – growing your business.



Dye-sub, UV, latex and screen printing services



Laser cutting



Expert finishing

Dye-sub, UV, latex and screen printing services  
**all available in-house**



# Saving you time to grow your business





Easy to Accessorise!

## 50mm Profile

From free-standing image walls to exhibition stands, Vector solutions offer you versatile designs that can be adapted to any type of environment.

With two different profiles individually suited to textile graphics or a rigid infill

Add stabilising feet for free-standing use

## 50mm Profile



- Quick assembly and disassembly
- Double sided graphics available
- Multiple profile options to create a seamless look
- Can be used as double-sided free-standing or wall-mounted
- Available in standard and custom-made modules
- Full graphic option, rounded corners

Model	Code	(h) x (w) x (d) mm
50 mm Vector	VKF-CUSTOM	Custom-made



Assembly of angled sections with push-button



50mm Aluminium profile



Screw different frames together



Corner rounded to 90°. Available in 50 or 100mm



90° angle for Full Graphic



Rounded corner for full graphic design



Specially designed exhibition solution!



Textile



Rigid

### Technical information

- Anodised aluminium 6063 T4
- Dimensions : 50 x 45 mm
- Weight per ml: 0.812kg
- Double-sided profile
- Push-button connector assembly
- Textile SEG or rigid infills

# 75mm LED Profile



Stand out with innovative and bright designs!



Assemble angled sections with screw-in bracket



Cabling system



LED 360mm

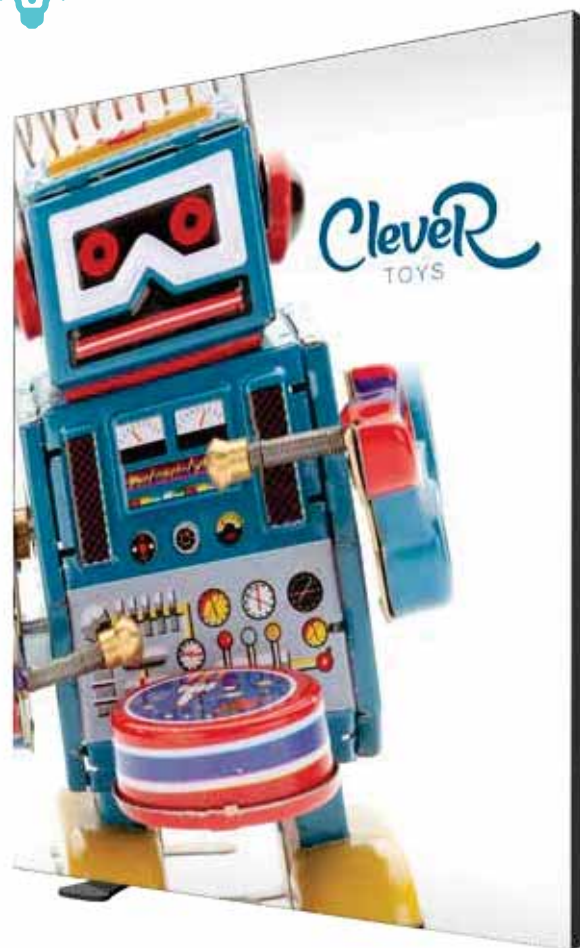

## 75mm LED Profile



- Single-sided wall-mounted
- LED linkable lighting system for consistent lighting across the graphic.
- Fix it directly to the wall for a large format wall decoration
- Two channels for inserting two visuals; create optical effects by layering graphics
- Available in standard and custom formats to suit any environment

Model	Code	(h) x (w) x (d) mm
75 mm Vector	VLB75-CUSTOM	Custom-made



Ideal for retail, banks, arenas, as pedestrian signage...



### Technical information

- Anodised aluminium 6063 T6
- Dimensions : 75 x 45 mm
- Weight per ml: 1,143 kg
- Assembly by screw brackets
- Optional rear recess for rigid infills
- SEG textile graphic

Use both sides!



## 100mm LED Profile

Economical light boxes, ideal for small series projects.



Assemble angled sections with screw-in bracket



Cabling system



LED 360mm

## 100mm LED Profile



- Free-standing, double-sided light frame
- LED linkable lighting system for consistent lighting across the graphic
- Economical solution, ideal for small format frames
- Available in standard and custom formats

Model	Code	(h) x (w) x (d) mm
100 mm Vector	VLB100-CUSTOM	Custom-made

Add stabilising feet for free-standing use



Flat feet FX295

LED linkable lighting system with transformer 24V



Point of sale, stands, hospitals, airports...



### Technical information

- Anodised aluminium 6063 T6
- Dimensions : 100 x 18 mm
- Weight per ml: 1,082kg
- Double sided system
- Assembly by screw-in bracket connectors
- SEG textile graphic

Use both sides!



# 125mm LED Profile

Create a maximum visibility for your brand communication with our exclusive double profile.



Assemble angled sections with screw-in bracket



Cabling system



LED 360mm

## 125mm LED Profile



- Free-standing, double-sided light frame
- LED linkable lighting system for consistent lighting across the graphic
- Double groove for inserting two graphics and creating an optical effect
- Very robust profile, ideal for large and very large format
- Available in standard and custom formats

Model	Code	(h) x (w) x (d) mm
125 mm Vector	VLB125-CUSTOM	Custom-made

Adding stabilising feet for free-standing use

LED linkable lighting system



Ideal for the shops, banks, cinemas, restaurants...



### Technical information

- Anodised aluminium 6063 T6
- Dimensions : 125 x 20 mm
- Weight per ml: 1,645 kg
- Dual face profile
- Assembly by screw brackets
- SEG textile graphic



# 150mm LED Profile

Light boxes, economical and ideal for series projects.

Ideal for retail, reception areas, airports, service stations, galleries...



Assemble angled sections with screw-in bracket



Cabling system



LED 360mm



## 150mm Profile



- Free-standing, double-sided light frame
- Economic solution
- LED linkable lighting system for consistent lighting across the graphic
- Also suitable for non-illuminated areas
- Available in standard and custom formats

Model	Code	(h) x (w) x (d) mm
150 mm Vector	VLB150-CUSTOM	Custom-made



Flat feet Retail FX295

Adding stabilising feet for free-standing use



Shop fittings, theatres, receptions, car showrooms...



### Technical information

- Anodised aluminium 6063 T6
- Dimensions : 150 x 18 mm
- Weight per ml: 1,542kg
- Double-sided profile
- Assembly by screw brackets
- SEG textile graphic

# LED, a technology of the future

LEDs are considered by many to be a future technology in the field of general lighting.

The LED modules are ideally suited for retail and exhibition environments. They create an even and consistent illumination of light boxes, whilst remaining cool. This economical, linkable, low-energy, long-life solution is the number one choice for back lighting.



## 24v Transformer for LED lighting



- Transformer for linkable and backlit lighting
- Connect up to five LED stripes in series
- Sleek design
- Integral fixing port for guiding the transformer inside the frame
- Cable system

Model	Code
24V Transformer	LED-RTL-01
Mains cable	LED-RTL-03



## Linkable LED lighting system



- Perfectly even lighting on large format frames without shadow
- Compatible with our single and double-sided frame solutions
- Wall and free-standing use
- The most economical solution on the market
- Simplified connectors for easy linking

Model	Code
LED strip (pair)	LED-RTL-05



### Technical information

- Voltage : 24V
- Power: max 75W
- Input : AC 110/240V
- Output : DC 24V
- Supplied with fixing kit, cables and cable grommet
- Certification CE/ROHS\*



### Technical information

- Length of module: 360 mm
- Power of a module including five lenses: 13 W - 24 V voltage
- Luminous flux: 450 lm - Light temperature: 6500 K
- Round LED lens diameter 21mm, optimised thanks to its angle of beam of 13 x 39°
- Link up to five LEDs to one transformer
- Simple and quick assembly
- Estimated life: 50 000 hrs
- Certification CE/ROHS\*
- One year warranty

## Vector Accessories



Literature Holders  
Vector / Linear

LN112-C

- Format A4



Wooden Shelf

- Available colours: ● ○ ● ●  
- Available in custom-made sizes



LED Floodlight

LED-FLOOD-ARM-BDLK



Quarter Side Foot

SLF1

- 220 x 220 x 5 mm



Half-Moon Foot (pair)

SLF2P

- 289 x 358 x 5 mm



LED Strip Light

LED-STRIP-ARM-BDLK



Flat Foot (unit)

LN155

- Metal, for free-standing frame  
- 75 x 350 x 3 mm



Flat Foot Retail (unit)

FX295

- Metal, for free-standing frame  
- 550 x 180 x 5 mm



LED Exhibition Light

LED-EXHIB-ARM-BDLK



Support iPad Design

IPAD-SH-360

- 360° Rotating iPad Holder  
- Secure frame  
- 310 x 225 x 95 mm  
- Compatible with all iPads except iPad mini and Pro  
- Available colours: ○ ● ●



Support for Screens

LN124-01 - Screens ≤ 80 cm

LN124A - Screens ≤ 94 cm

LN124 - Screens ≤ 106 cm

- Post or beam fixing

Combine all the advantages of Vector frames with optional additional accessories to create your custom-made display solution!

# Vector Modules

## Scalable solutions for your needs and budget

From the free-standing image wall to the exhibition stand, Vector Modules offer you versatile designs that can be adapted to any type of event.

This gives you the freedom to redevelop your stand as many times as you want, thus guaranteeing an excellent return on investment.

Each module is manufactured with 50mm aluminium profiles, supplied in sections of 1.25m and delivered in cardboard with assembly instructions. They are ready to be used with the visual of your choice. To ensure the shortest possible time, modules are available from stock.

Once your event is over, decide to store your booth at home, in a small box (1350 x 400 x 300mm) or re-use one of the modules to dress up your showroom.

Go from a stand 3m<sup>2</sup> to a stand 15m<sup>2</sup> in the blink of an eye!

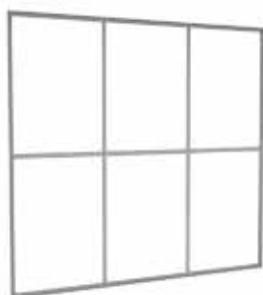

### Module A



- Standard channel on four sides
- Vector to Vector fixings included

Model	Code	(h) x (w) mm
3m Module	MODULE-VFF-A	2500 x 2950 mm



### Module B



- Standard channel on four sides
- Vector to Vector fixings included

Model	Code	(h) x (w) mm
2m Module	MODULE-VFF-B	2500 x 1950 mm



### Module C



- Standard channel on four sides
- Vector to Vector fixings included

Model	Code	(h) x (w) mm
1m Module	MODULE-VFF-C	2500 x 950 mm



### Module D



- Modular arch
- Two junction profiles 950mm included
- Beam Attachment Included
- Flat Feet (LN155) included
- Double-sided profile
- Possibility of adding recessed spotlights and a screen holder

Model	Code	(h) x (w) x (d) mm
Arch	MODULE-VFF-D	Roof: 2500 x 950 mm Inside: 2500 x 950 mm Outside: 2550 x 950 x 2600 mm





## Module E



- Post in two parts of 1250 mm

Model	Code	(h) x (w) mm
Square Beam	MODULE-VFF-E	2500 x 50 mm

Used to connect two frames at right angles



## Module F



- Door with threshold bar
- Lock with keys

Model	Code	(h) x (w) mm
Door	MODULE-VFF-F	Pediment: 545 x 950 mm Door: 1940 x 942 mm

Ideal for creating return configurations



## Module G



- Corner storage with lockable door
- Two visible faces
- Standard channel on four sides
- Create a taller storage area with the addition of module K
- Vector and Vector Beam Attachments Included

Model	Code	(h) x (w) x (d) mm
Return	MODULE-VFF-G	2500 x 950 x 950 mm Inside: 545 x 950 mm Door: 1940 x 942 mm



## Module H



- Full graphic arch
- Double-sided dressing
- Possibility of adding recessed spotlights under the overhanging canopy
- Ability to add a TV stand on the front panel
- Flat Feet (LN155) included

Model	Code	(h) x (w) x (d) mm
Rounded Arch	MODULE-VFF-H	2550 x 950 x 2600 mm

Full graphic surround



## Module I



- LED frame 100mm double face
- Including stabiliser feet
- Four LED strips and one transformer included
- Two junction profiles 950mm included
- Flat Feet (FX295) included

Model	Code	(h) x (w) mm
Advanced LED Arch	MODULE-VFF-I	2550 x 950 mm

Ideal for creating an LED arch by combining it with a C module



## Module J



- Single-sided 75mm LED frame
- Four LED strips and one transformer included
- Vector and Vector Beam Attachments Included

Model	Code	(h) x (w) mm
LED Module	MODULE-VFF-J	2500 x 950 mm



## Module K



- Extends full graphic to fit on a square return (module G)
- Fixings included

Model	Code	(h) x (w) x (d) mm
Return Upgrade	MODULE-VFF-J	1000 x 1050 x 1050 mm

Four customisable faces

### Tips & Tricks

+ Accessorise your modules with literature holders, shelves or screen mounts

+ Use our modular briefs to better guide your customer

# Accent Hybrids Vector

Give your display an Accent and stand-out!

The curves of Formulate combined with the Vector range create an original and innovative display solution. A multitude of custom-made configurations is possible, we offer standard shapes and sizes that are simple to incorporate with our Vector modules.

Each Accent is ready-to-use and includes the necessary elements to adapt it to a module in the Vector range. Choose from one of six Accent Formulates to give depth to your free-standing projects or modular stands.

- Tubular aluminium structure diameter 30mm
- Mounting on Vector frame by locks or clips
- Fabric graphic with zip system
- Double-sided customisation
- Numbered parts
- Simple to build



Attached to frames by lock and Allen key



Fixing by metal or plastic clamp system



Graphic fabric with zip system

## NEW Accent 18 Half Cap



Model	Code	(h) x (w) x (d) mm
Half cap	FMLT-WL18-V	2660 x 1990 x 500 mm

## NEW Accent 16 Cap



Model	Code	(h) x (w) x (d) mm
Cap	FMLT-WL16-V	2660 x 1990 x 500 mm



\*Vector wall not included

Brand up  
both sides



\*Vector wall not included

↑ Ideal for dressing up walls

**Accent 17 Advanced Trapeze**



Model	Code	↗ (h) x (w) x (d) mm
Advanced Trapeze	FMLT-WL17-V	2660 x 1700 x 181 mm



\*Vector wall not included

**Accent 15 Small Advanced**



Model	Code	↗ (h) x (w) x (d) mm
Small advanced	FMLT-WL15-V	2660 x 407 x 450 mm



\*Vector wall not included

Attract attention with original shapes

**Accent 14 Advanced**



Model	Code	↗ (h) x (w) x (d) mm
Advanced	FMLT-WL14-V	2660 x 1219 x 407 mm



\*Vector wall not included

**Accent 19 Curved roof**



Model	Code	↗ (h) x (w) x (d) mm
Curved Roof	FMLT-WL19-V	365 x 2200 x 1030 mm



\*Vector wall not included

Create extra height in a unique way

# Vector Modules

## Free-standing

### 3m Wall



- 50mm profile aluminium frame
- Textile display with SEG

Model	Code
Module A (x1)	MODULE-VFF-A
Pair of half-moon feet	SLF2P



Half moon feet  
Code : SLF2P



Ideal for creating large picture walls or partition walls



Easy to Carry

Carry your entire stand in one bag

### 6m Wall



- Profiled aluminium frames 50mm
- Fabric graphic with SEG

Model	Code
Module A (x2)	MODULE-VFF-A
Pair of half moon feet	SLF2P
Flat feet (x4)	LN155
Light 120 Watt (x3)	PS1000-103E
Light fixings (x3)	VLF



Powerspot 1000  
Code: PS1000-103E



Flat feet  
Code: LN155

Assemble multiple modules side by side to create longer image walls



Design Ideas!

You can attach halogen or LED spotlights to your free-standing frames to illuminate your stand.

Stabilising Feet

For optimum stability of your structure, add feet at regular intervals.





# Vector Modules

## Stand 9m<sup>2</sup>



Storage room

Return of 1m<sup>2</sup> with secured lock. For more stability, the returns are equipped with a threshold bar at the bottom of the doors.

Hybrid solution

Aluminium mounting tubes 30mm diameter

Square foot

Metal foot for optimal stability of your walls

## Stand 9m<sup>2</sup>



- Profiled aluminium frames 50mm
- Accent Formulate with Ø30mm tubes
- Fabric graphic with SEG

Model	Code
Module B (x2)	MODULE-VFF-B
Module G	MODULE-VFF-G
Accent 17	FMLT-WL17-V
Accent 15	FMLT-WL15-V
Square feet (x2)	SLF1
Light 120 Watt (x2)	PS1000-103E
Fixation spot (x2)	VLF



Possibility to add LED spotlight kit  
Code : LED-EXHIB-ARM-BDLK



Square foot  
Code: SLF1



Door return with lock and key set



# 3D designservice

**Using the latest CAD software technology,** our experienced 3D design team will work with you to design and then render your exhibition display stand so you can view before you buy.



# Vector Modules

## Stand 15m<sup>2</sup>

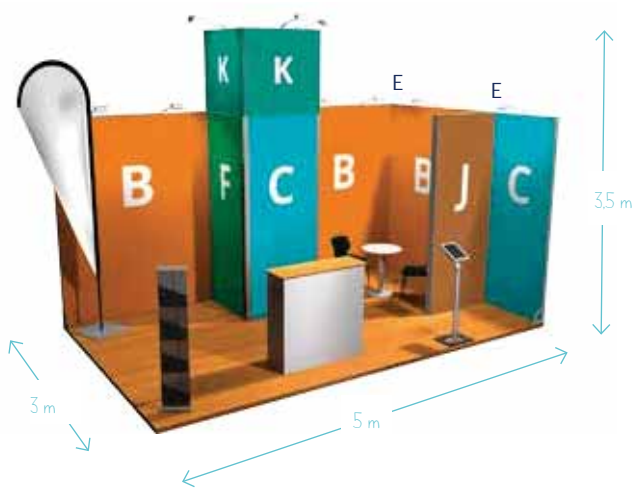

### 15m<sup>2</sup> Stand



- Profiled aluminium frames 50mm
- Return with extension
- Fabric graphic with SEG

Model	Code
Module C (x3)	MODULE-VFF-C
Module F	MODULE-VFF-F
Module E (x6)	MODULE-VFF-E
Module B (x3)	MODULE-VFF-B
Module J	MODULE-VFF-J
Module K	MODULE-VFF-K
Square feet (x2)	SLF1
Light 120 Watt (x9)	PS1000-103E
Light fixing (x9)	VLF

### Return upgrade

Gain visibility and originality with this large return customisable on the four sides



Square post to create 90° angles



Square Feet Code: KIT SLF1



Door return with lock and key set



Large format graphics

Create a meeting area within your stand



### LED Module

Using Module J is a great way to add light to your stand and get you noticed

Add literature or documents to your stand

Xanadu Literature holder - Code: WH431

Vector profiles can also be used to build reception desks

Vector Straight Counter - Code: VSCB

Showcase your website with a tablet holder

Free-standing tablet holder - Code: TS-001-W



# Vector Modules

## Stand 15m<sup>2</sup>



### LED light sign

Creating a suspended sign is possible using a 125mm Vector Profile. An ideal solution to attract the attention of passers-by.



Metal hooks fixed to the structure allow you to suspend the LED frame (suspension cables not included)

### Double-sided customisation



### TV Screen

Enhance your stand by streaming videos. Several models can be added to the Vector Walls



\* Screen not included



### Hybrid solution

Tubular structure of 30mm. Fixing to the Vector frame by a system of locks and clamps

## 15m<sup>2</sup> Stand



- Profiled aluminium frames 50mm
- Return of 1m<sup>2</sup>
- Hybrid accent in aluminium tube of Ø30mm, fabric graphic with zip system
- Fabric graphic with SEG

Model	Code
Module B (x2)	MODULE-VFF-B
Module C (x2)	MODULE-VFF-C
Module F	MODULE-VFF-F
Module E (x6)	MODULE-VFF-E
Accent 16	FMLT-WL16-V
Light 120 Watt (x2)	PS1000-103E
Light fixing (x2)	VLF

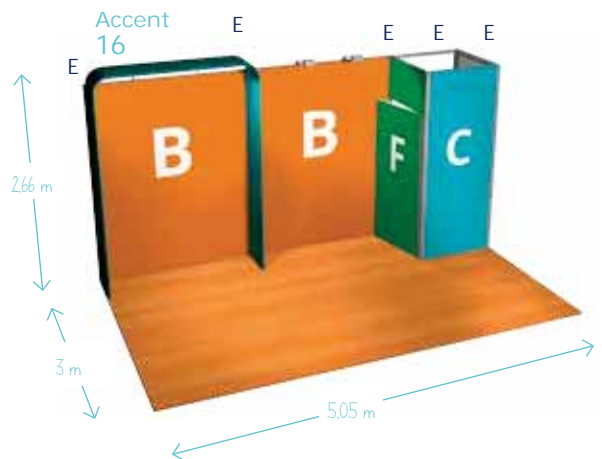



# Vector Modules

## Stand 18m<sup>2</sup>



### Accessories

Make your stand more attractive and functional by adding literature holders or shelves

### Storage room

1m<sup>2</sup> return with secured lock. For more stability, the returns are equipped with a threshold bar at the bottom of the doors.

Create large graphics by adding different modules



Add additional extra custom-made shelves

## 18m<sup>2</sup> Stand



- Profiled aluminium frames 50mm
- Arch with rounded edge
- Printed fabric graphic with SEG

Model	Code
Module B (x3)	MODULE-VFF-B
Module G	MODULE-VFF-G
Module C	MODULE-VFF-C
Module H	MODULE-VFF-H
Square feet (x2)	SLF1
Light 120 Watt (x6)	PS1000-103E
Light fixings (x6)	VLF

### Rounded arch and full graphic

Full graphic front and back. Add more light to your stand with built-in LED spotlights directly under the canopy of the arch.

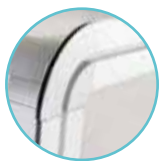

Rounded corner for full graphic design



Door return with lock and key set



# Vector Modules

## Stand 18m<sup>2</sup>

### 18m<sup>2</sup> Stand



- Profiled aluminium frames 50mm
- 2m<sup>2</sup> Storage area
- Hybrid accent in aluminium tube of Ø30mm, fabric graphic with zip system
- Fabric graphic with SEG

Model	Code
Module B (x3)	MODULE-VFF-B
Module F	MODULE-VFF-F
Module C	MODULE-VFF-C
Module E (x6)	MODULE-VFF-E
Module V	MODULE-LN-V
Beam 950mm (x6)	LN605-950-L2
Accent 18 (x2)	FMLT-WL18-V
Accent 19	FMLT-WL19-V
Light 120 Watt (x2)	PS1000-103E
Light fixings (x2)	VLF

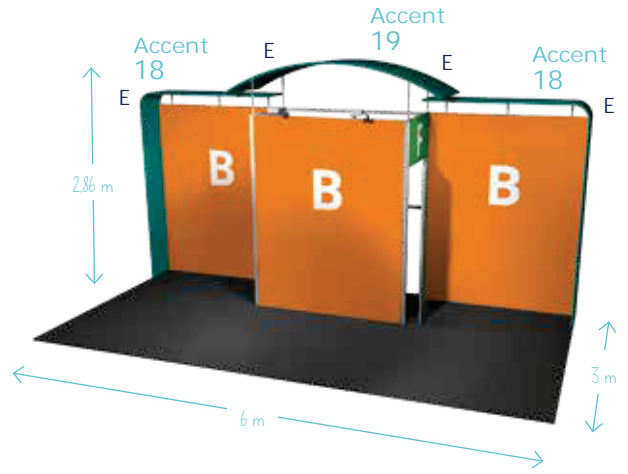

Hybrid structures attached to a Vector frame



Square Beam to create 90° angles



Door return with lock and key set



Possibility to add LED spotlights  
Code : LED-EXHIB-ARM-BDLK

Increase visibility and create unique hybrid solutions

Aluminium tubes of 30mm diameter

Half cap

Very large format graphics



# Vector Modules

## Stand 49m<sup>2</sup>

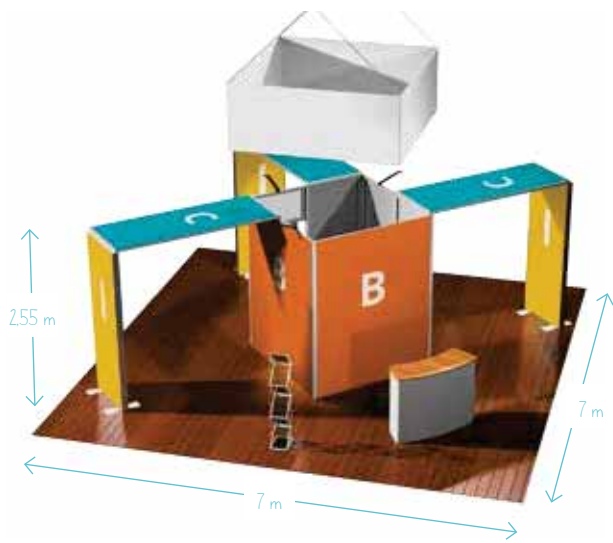

### 49m<sup>2</sup> Stand



- Profiled aluminium frames 50mm
- Large storage capacity
- Tubular hanging sign with textile cover
- Fabric graphic with SEG

Model	Code
Module B (x3)	MODULE-VFF-B
Module C (x4)	MODULE-VFF-C
Module I (x3)	MODULE-VFF-I
Module F	MODULE-VFF-F
Module E (x5)	MODULE-VFF-E
Transformers (x3)	LED-ARM-TRANS



Arches with stabilising feet



Door return with lock and key set

### Suspended Formulate Hanging Structure

Each hanging structure has metal attachment points attached to the structure, cables not supplied



### LED Light

The LED spots offer a power of 80 Watt while consuming little energy.



Create a light arch by combining modules I and C

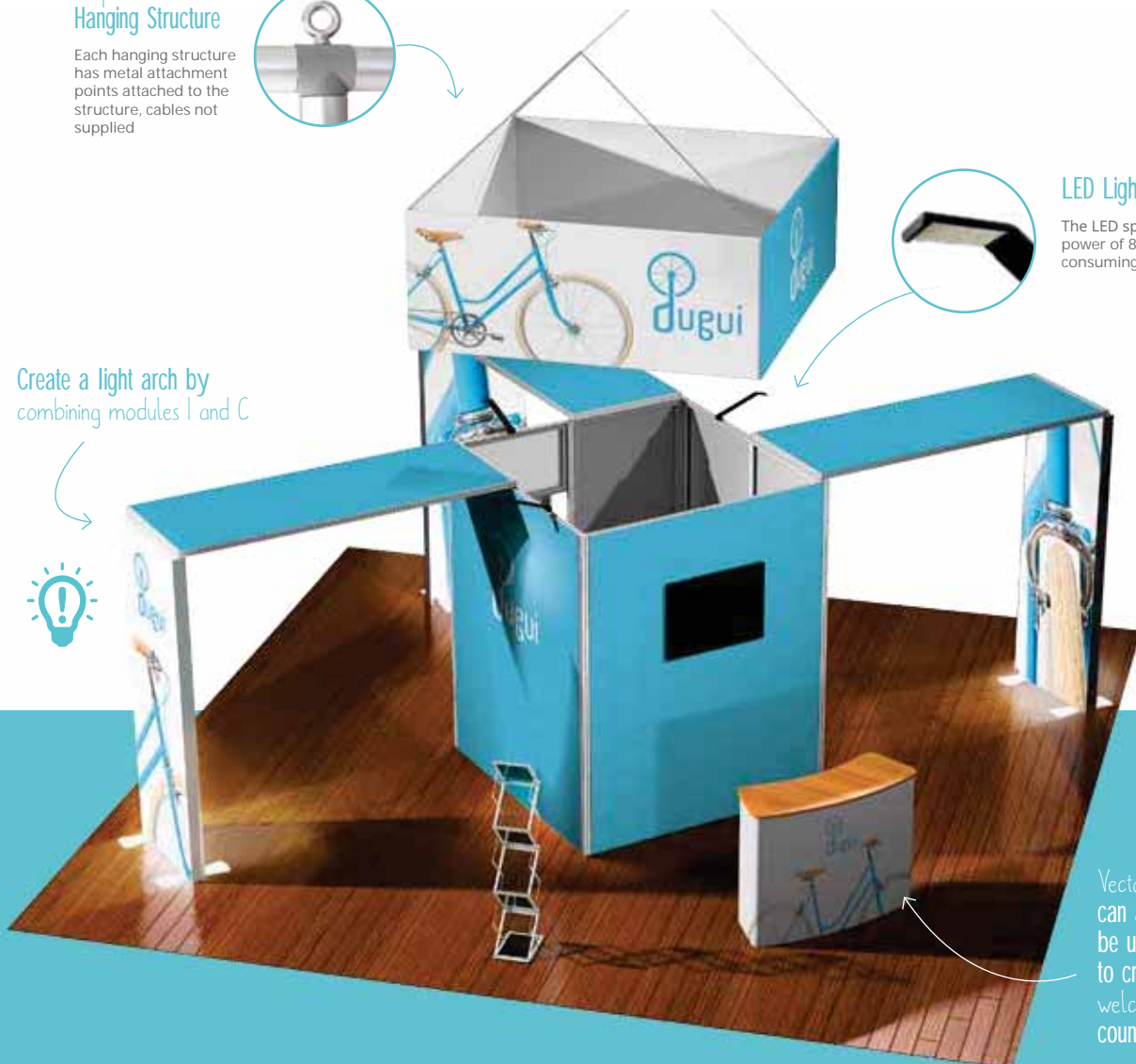

\* Screen not included

Vector profiles can also be used to create welcome counters



# Custom-made Vector Stands

## 15m<sup>2</sup> Stand



- Profiled aluminium frames 50mm
- Fabric graphic with SEG

### Full Graphic Counter

Customised counter tops with rounded corners. Available in several colours

Halogen spotlights with 360° swivel head

### Rounded corners

More dynamic structures thanks to rounded corner profiles. Available in 50mm or 100mm wide



### Winning in height

Give volume to your stands by adding walls up to 3.5 m high

### Frame with rounded corners

Create partitions and reception areas for your clients.

## Vector Quick Fix

20mm aluminium frame. Printed fabric graphic with SEG. Ideal to decorate your booth and give volume.

### Be seen!

Increase the height of your backwall and increase your visibility by using a return extension

## Stand 18m<sup>2</sup>



- Profiled aluminium frames 50mm
- 3m<sup>2</sup> large storage space
- Fabric graphic with SEG



### TV Screen

Enhance your stand by streaming videos. Several models can be added to the Vector Walls

\*Screen not included

Use Vector profiles to create furniture or eye-catching decorations





1. Kit Panel LCD
2. Linear Executive Wave

# Linear

The Linear range is perfect for applications such as image walls, stands and office layouts. It comprises aluminium frames used to provide the basis of a durable and solid structure, which can be used on a permanent or temporary bases.

You can take full advantage of this range in its many different forms by combining it with our Vector range to create secure storage spaces.



## Linear – versatile in profile ranges and print media

A wide range of profile shapes

Linear is a modular solution made up of several aluminium frames. It has been designed to offer an alternative to frames with fabric graphics. Its construction is based on channelled posts and strengthening cross-beams and it therefore allows you to add flexible printed PVC graphics or rigid printed panels to your structures.

### // Assembling Linear

Linear frames can be slotted in thanks to a system of connectors, an integral part of the frame. At its most basic, all that is needed is one male pole and one female pole.

Assembly of a pole and a cross-beam using an Allen key to lock in place.



Lock in place using Allen key

### // Anodised aluminium posts and beams with channel profiles



LN601 - 50mm round post - four connections

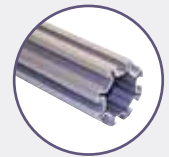

LN618 - 50mm round post - eight connections



LN602 - 75mm round post - four connections



LN8W - 75mm round post - eight connections

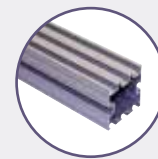

LN616 - 50mm square post - eight connections

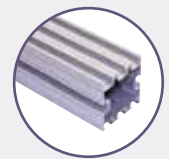

LN607 - 75mm square post - eight connections

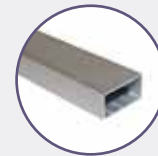

LN625 - 30mm beam

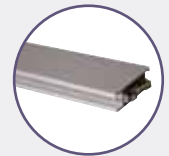

LN605 - 45mm beam



LN619 - 50mm Oval beam

### // Options for frame covering

Whatever materials you intend to use, you can choose to cover the frame either fully or partially.

- A If you choose a flexible PVC graphic, an adhesive magnetic tape needs to be fixed to the back of the visual. A metal tape is bonded to the frame for the magnetic tape to fix to.

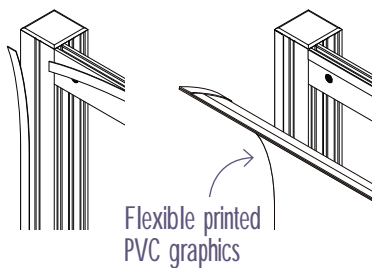

Flexible printed PVC graphics

- B If you choose a cover made of rigid panels (5mm), you can insert each panel in the channel. If you intend to cover the whole structure, hook and loop can be fitted to the back and on to the frame.

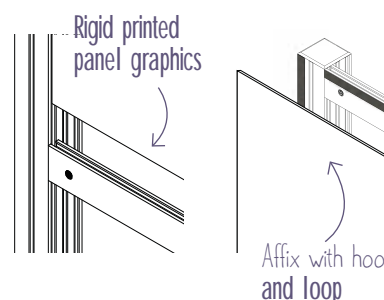

Rigid printed panel graphics

Affix with hook and loop

# Linear Backwalls

The Linear range is ideally suited for wall applications, stands and office fixtures.

- Linear anodised aluminium profiles with four connections
- Cover with flexible PVC or rigid (5mm) printed panels
- Standard kits supplied with a roll of metal tape (additional magnetic tape EM301 - not included)
- Optional accessories available



Coded system

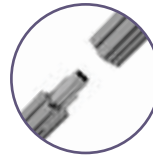

Male and female post connectors



Connection of Linear male and female beams



\* Screen not included

## Linear Executive Wave



Model	Code	(h) x (w) x (d) mm
2 LCD and 4 shelves	LK031-001	2475 x 3000 x 500 mm
2 LCD and 4 literature holders	LK031-002	2475 x 3000 x 500 mm
6 Literature holders	LK031-003	2475 x 3000 x 500 mm

## Linear Executive Curve



Model	Code	(h) x (w) x (d) mm
2 LCD and 4 shelves	LK030-001	2475 x 3000 x 500 mm
2 LCD and 4 literature holders	LK030-002	2475 x 3000 x 500 mm
6 Literature holders	LK030-003	2475 x 3000 x 500 mm



Curved steel bases

Accessories posts



Optional extra iPad Holder

Top caps complete the look

### Kit A - Curved Panel



Model	Code	(h) x (w) x (d) mm
Panel 1000	LK023-C	2000 x 1265 x 390 mm
Panel 2000	LK023-D	2000 x 2245 x 455 mm
Panel 3000	LK023-E	2000 x 3110 x 740 mm

### Kit LCD Panel



Model	Code	(h) x (w) x (d) mm
Panel 1000	LK025-C	2000 x 1250 x 400 mm
Panel 2000	LK025-D	2000 x 2250 x 400 mm
Panel 3000	LK025-E	2000 x 3250 x 400 mm

### Kit B - Straight Panel



Model	Code	(h) x (w) x (d) mm
Panel 1000 x 2000	LK021-A	1000 x 2550 x 400 mm
Panel 2000 x 500	LK021-B	2000 x 1050 x 400 mm
Panel 2000 x 1000	LK021-C	2000 x 1550 x 400 mm
Panel 2000 x 2000	LK021-D	2000 x 2550 x 400 mm
Panel 2000 x 3000	LK021-E	2000 x 3550 x 400 mm

## Linear Accessories

Make Linear structures more functional by accessorising

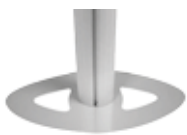

Oval Steel Base  
LN114-S  
- 400 x 175 mm  
- 1.8 kg



Domed Base  
LN102 (base)  
LN900 (weight)  
- Ø450 mm  
- 16.5 kg



Slim Foot  
LN155  
- Metal foot for self-supporting frame  
- 75 x 350 x 3 mm  
- 1.75 kg



Quarter Side Foot  
SLF1  
- 220 x 220 x 5 mm  
- 1.2 kg



Side Foot (pair)  
SLF2P  
- 289 x 358 x 5 mm  
- 1.8 kg



Side table  
LN319  
- Available in several colours:  
● ● ● ●



Designer iPad Holder  
IPAD-CHU  
- 310 x 225 x 20 mm  
- Secure frame  
- Available in white, silver and black  
- Compatible with all iPads except iPad mini and Pro



Screen Brackets  
LN124-01 Screen ≤ 80cm  
LN124A Screen ≤ 94cm  
LN124 Screen ≤ 106cm  
- Post or beam fixing



Shelving  
LN130  
- Available in several colours:  
● ● ● ●



Literature Holder  
AH5A4P (A4)  
AH5A5P (A5)  
AH5DLP (DL)  
- Injection moulded literature holders  
- Can also be wall mounted



Acrylic Literature Holder  
LN501  
- A4 size



Metal Literature Holder  
LN112-C  
- A4 size



# Linear Modules

Linear is supplied in five modules that can be combined to create different configurations.

The posts are cut into 1.25m long sections which makes transportation and storage much easier.

## Solutions that can expand to fit any space and budget

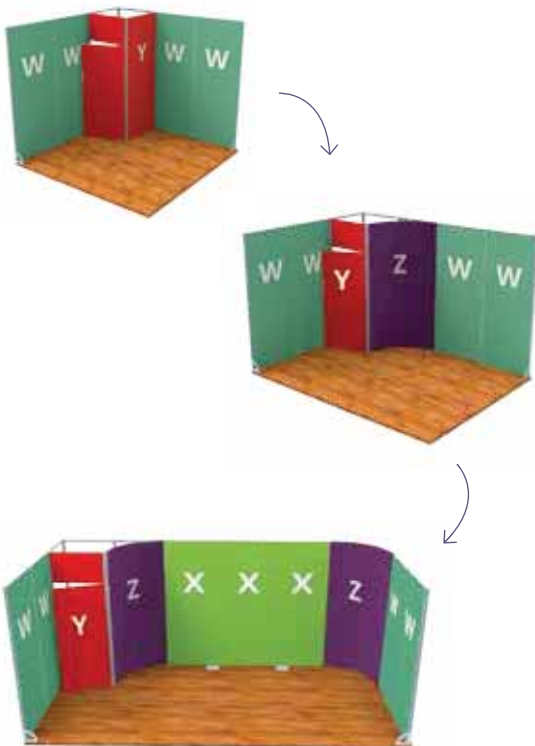

### Module V



- 1250mm two part post

Model	Code	(h) x (w) x (d) mm
Square post	MODULE-LN-V	2500 x 50 x 50 mm



### Module W



- Composed of one post and three beams

Model	Code	(h) x (w) x (d) mm
Module 950mm	MODULE-LN-W	2500 x 950 x 50 mm



### Module X



- Composed of one post and three beams

Model	Code	(h) x (w) x (d) mm
Module 1050mm	MODULE-LN-X	2500 x 1050 x 50 mm



### Module Y



- Lockable door  
- Strengthening threshold bar

Model	Code	(h) x (w) x (d) mm
Linear Door	MODULE-LN-Y	2500 x 1000 x 1000 mm



### Module Z



- Set of beams  
- Post not included

Model	Code	(h) x (w) mm
Curved Module	MODULE-LN-Z	2500 x 950 mm Radius : 1435 mm

#### Tips

+ The curved module can be used in concave or convex position

+ Combine modules W and X for a wider module

# Linear Modules

## Linear 9m<sup>2</sup>

### Stand 9m<sup>2</sup>



- 50mm square profile aluminium frames
- Suitable for graphics in rollable PVC or printed rigid panels

Model	Code
Module W (x6)	MODULE-LN-W
Module V	MODULE-LN-V
Quarter side foot (x2)	SLF1
Spot 120 Watt (x6)	PS1000-103E
Light fixings (x6)	US-LINEAR



Quarter side foot  
Code : KIT SLF1

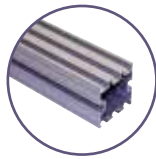

50mm Square post  
eight connections



Simple assembly

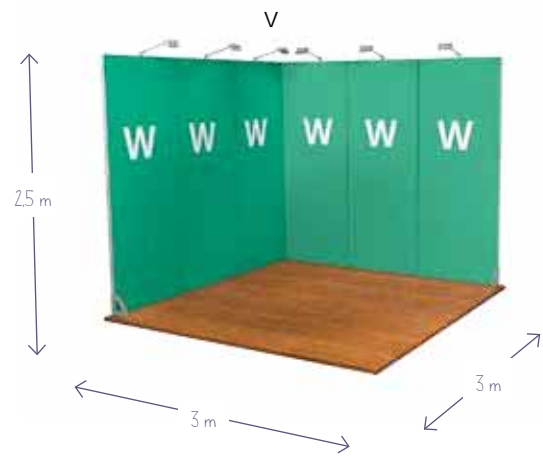

Use multiple modules to create a large format display solution

Discrete frame



Optional extra stabilising feet

# Linear Modules

## Linear 15m<sup>2</sup>

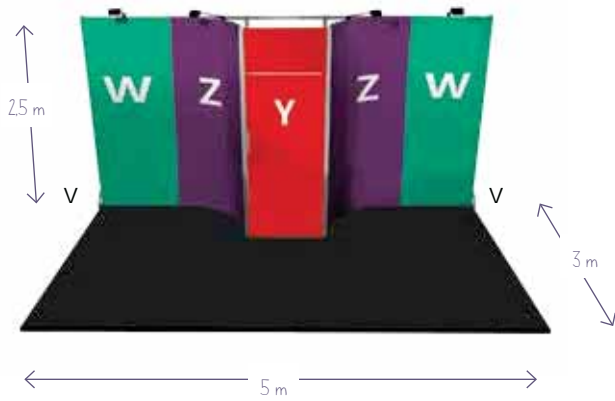

### Stand 15m<sup>2</sup>



- 50mm square profile aluminium frames
- Sleek central storage area
- Suitable for graphics in rollable PVC or printed rigid Panels

Model	Code
Module W (x2)	MODULE-LN-W
Module V (x2)	MODULE-LN-V
Module Z (x2)	MODULE-LN-Z
Module Y	MODULE-LN-Y
Quarter side foot (x2)	SLF1
Spot 120 Watt (x4)	PS1000-203E
Light fixings (x4)	US-LINEAR



Quarter side foot  
Code : SLF1



Curved beams



Secure closure

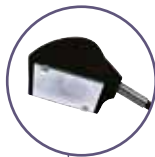

#### Halogen spotlights

Use optional extra black spotlights to make your stand graphics more vibrant

#### Storage room

Central storage room with lock for extra security. For more stability, the returns are equipped with a strengthening threshold bar at the bottom of the doors.

Stand out from the crowd with large format visuals



# Linear Modules

## Linear 18m<sup>2</sup>

Use multiple panels to create a large format display solution



PVC graphic

PVC graphic panels are particularly suitable for curved shapes

Large curved return



Optional extra stabilising feet

### Stand 18m<sup>2</sup>



- 50mm square profile aluminium frames
- Large storage capacity
- Suitable for visuals in rollablePVC or printed rigid graphic panels

#### Model

Module V (x2)  
Module W (x4)  
Module X (x2)  
Module Y  
Module Z  
Quarter side foot  
Spot 120 Watt (x7)  
Light fixings (x7)

#### Code

MODULE-LN-V  
MODULE-LN-W  
MODULE-LN-X  
MODULE-LN-Y  
MODULE-LN-Z  
KIT SLF1  
PS1000-103E  
US-LINEAR

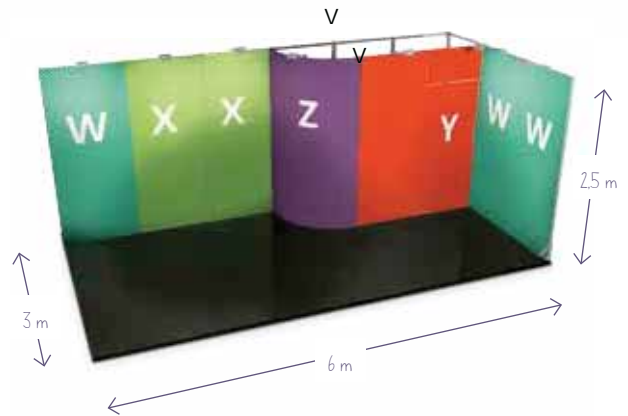

Ability to add LED spotlights  
Code: LED-EXHIB-ARM-BDLK



Secure closure



Simple assembly





1. Stand Arena 12m<sup>2</sup>
2. Arena Free-standing

# Arena

If your visual communications project is about handling space and layout, the organisation of an event or communications activity, we have the solution: the solution is ARENA.

The Arena framework is a visually attractive structure made up of aluminium tubes. It is a modular solution which is extremely stable and highly scalable. The various sections can be assembled, re-configured and re-used according to the requirements of each event.



Aluminium structure

## Arena Structures

The 25mm aluminium tubes of the ARENA modular solution can be assembled and fixed together to create sections of various shapes and sizes in order to build the foundations of an imposing and solid stand structure.

A wide selection of tubular sections can be supplied to create a bespoke solution that meets your exact requirements.

### // Assembling Arena

Components are supplied including nine straight sections, to create the structure you need, based on the type of transportation you select.

Create tailor-made display solutions with Arena components



Corner swivel plate  
UT-SP01



45° Triangular foot  
UT-AF250



90° Angle Two-way corner  
UT-C21



Three-way corner  
UT-C30



250mm Hook over plate  
UT-HP250



Four-way T connector  
UT-C40



Three-way T connector  
UT-C35



250mm Foot  
UT-BS250



Four-way connector  
UT-C41



Five-way connector  
UT-C55



Six-way connector  
UT-C65



500mm Curved section  
UT-C500



1000mm Curved section  
UT-C1000



Section 250mm  
UT-S250

Section 750mm  
UT-S750

Section 1500mm  
UT-S1500

Section 300mm  
UT-S300

Section 1000mm  
UT-S1000

Section 1750mm  
UT-S1750

Section 500mm  
UT-S500

Section 1250mm  
UT-S1250

Section 2000mm  
UT-S2000

## Simple assembly without tools

The various sections can be put together using the screws and nuts supplied; so no additional tools are required for the assembly. The graphics (PVC or textile) are then secured using eyelets and bungee cords. Maximum visibility can be achieved by using six metre long spans that do not require any reinforcement. Tip: this also can be used as lighting structures.

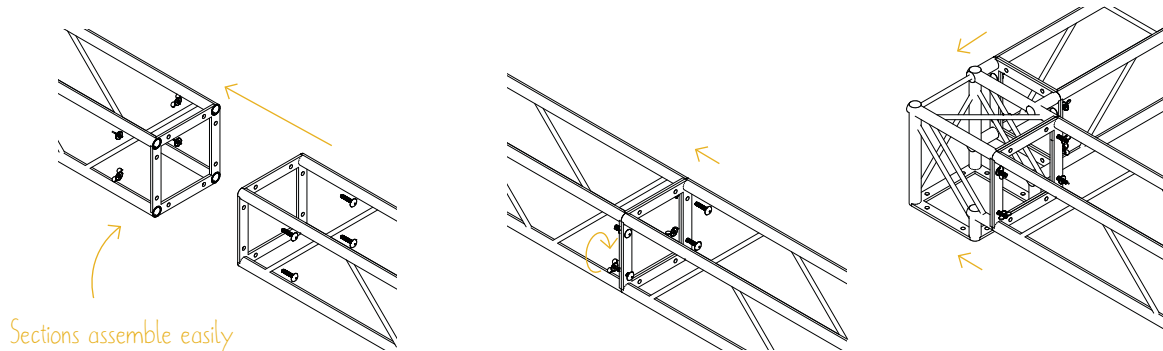

Sections assemble easily

## // Arena Accessories

Gain functionality from an Arena stand by accessorising with screens, literature holders or shelves. You can also use the Arena structures as a light gantry by adding halogen spotlights.



LCD Screen bracket ≤ 40 kg  
UT-LCD3



LCD Screen bracket ≤ 15 kg  
UT-LCD1



Metal literature holders  
TT401  
- Ten storage compartments



Oval table  
TT400



Half table  
Shown as a pair, sold singularly  
TT400-2



Corner table  
TT400-1

Tables available in several colours: ● ○ ● ●

# Arena Stands

- 25mm dia. aluminium tubular structure
- Graphic attached by bungee fixings
- Accessorise with shelves, literature rack, spotlights

Free-standing wall



Striking structures!

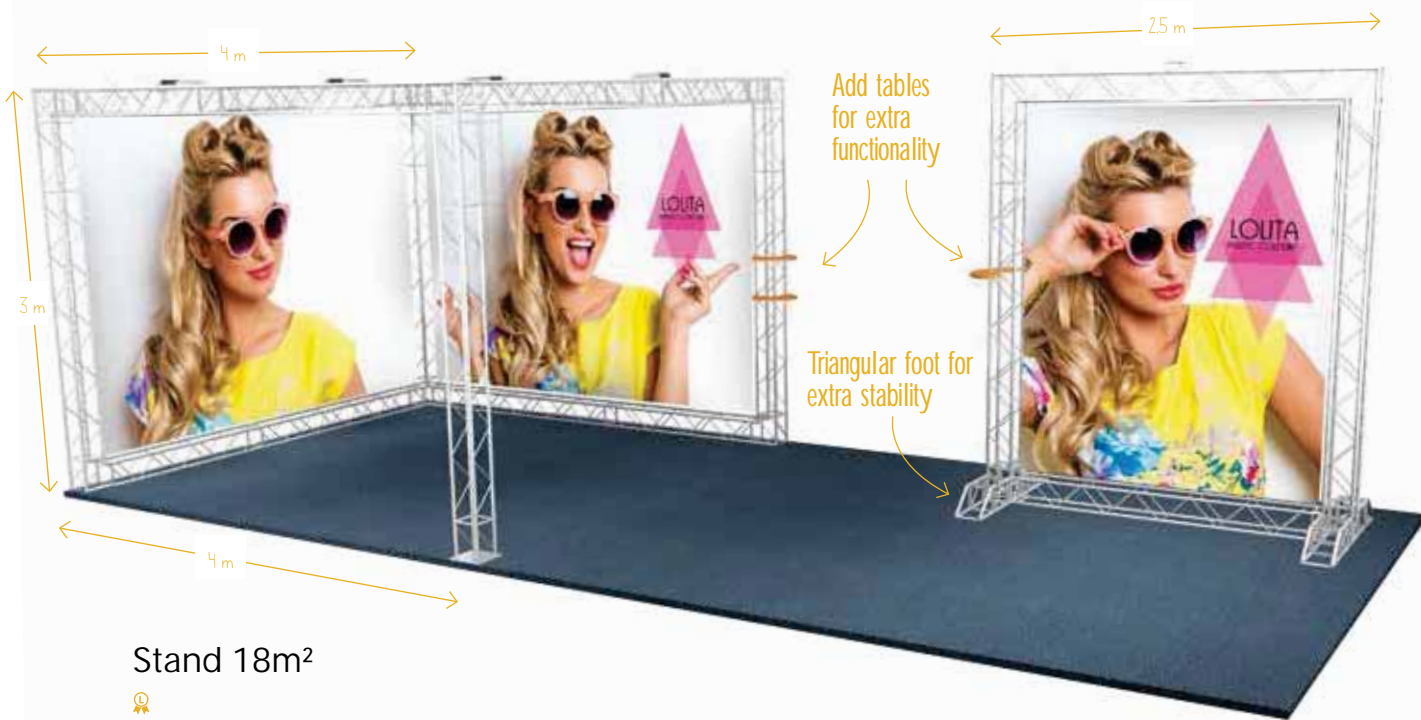

Ideal for double-sided graphics

Great stability

Arena Kit 1



Shelving

Attach shelves or literature racks to your structure to increase functionality





## Arena Kit 4

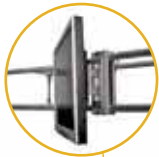
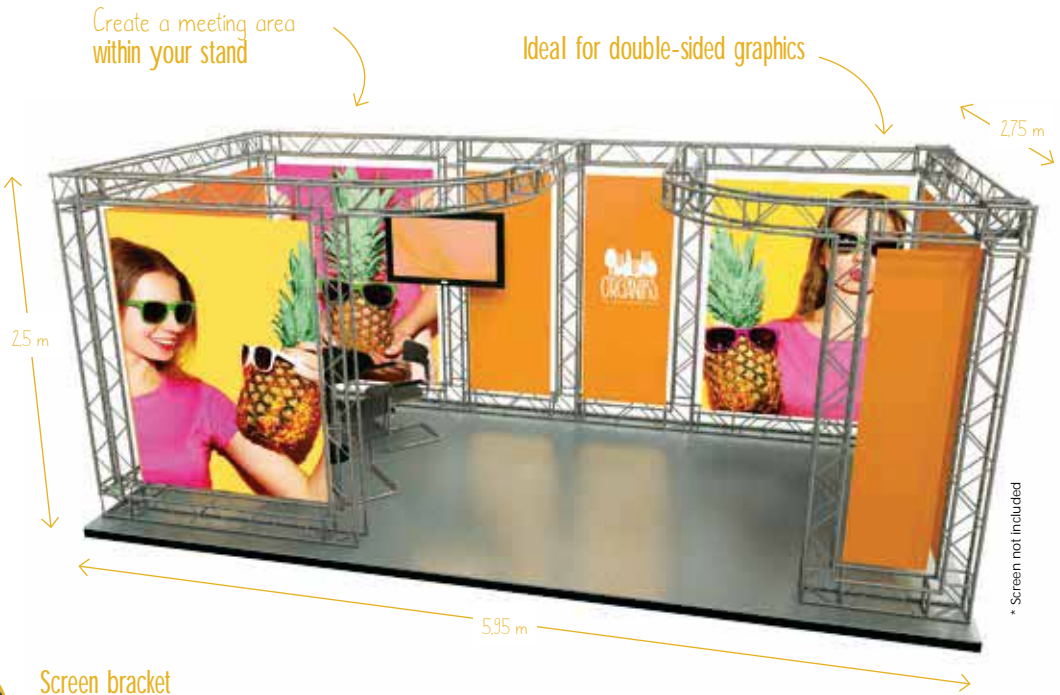

### Screen bracket

Enhance your stand by streaming videos. Several models of screen holders can be added to Arena structures

Gain height and extra visibility!

## Arena Kit 5



### Mount without tools

Arena are strong light-weight structures and assemble easily without tools. Bolts and nuts are provided for each element.

## Arena Kit 6

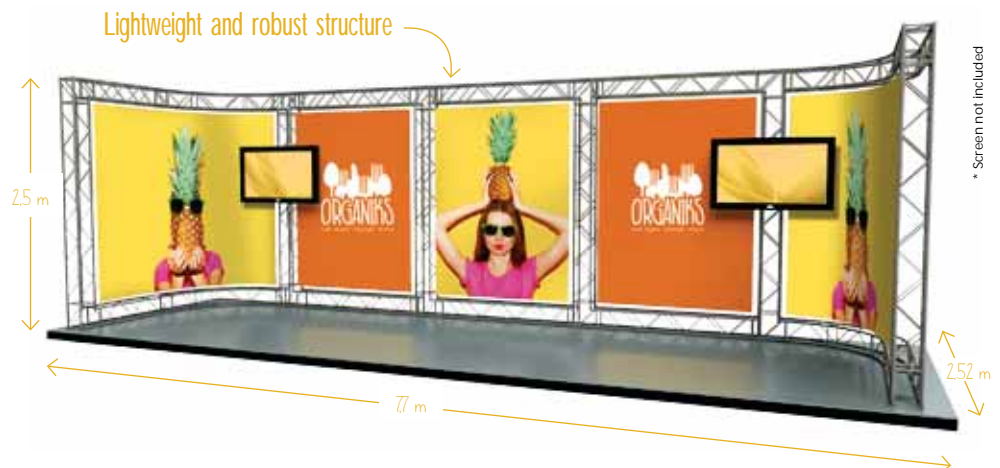

Arena structures support up to 100kg for a range of 2m

## Dramatic Structures

Arena has been the structure of choice for the world of stage and theatre for many years. It's versatility means it is used for lighting gantries to regulate lighting uniformly on a stage as well as forming large graphic walls or arches.

By creating your own configuration, you ensure both a secure assembly of your event and bring a touch of originality depending on the layout of the elements.



Gantries aren't just for lighting!  
Get your brand communicating  
from on high

### Arena 36 m<sup>2</sup>



- Aluminium structure
- Ø25mm tubes
- Accessories available

Up to 6m long without  
need for reinforcement





1. Wooden transport box

# Accessories

Whether you are finishing an exhibition stand, a point of sale or a specific event, our modular solutions can be enhanced by a large selection of accessories such as counters, document stands and lighting solutions.

We also have a range of appropriate transportation solutions (bags and cases in hard and soft materials) to suit your requirements.



# Literature Holders Accessories

Displaying your documentation in a prominent, eye-catching way so that stand visitors will pick it up and take it away is an absolute must for communications professionals. Our literature holders, available in a vast choice of materials and finishes to be used in all kinds of environments, are the ideal complement to your modular stand solution.

## NEW Quantum



- Black plastic collapsible double-sided literature holder
- Five A4 pockets
- Foamed premium carry bag

Model	Code	(h) x (w) x (d) mm
Quantum	AS316-01	1320 x 285 x 380 mm

Double-sided



New ultra compact design



## Linear media post



- Portable and easy to assemble
- Anodised aluminium construction
- Three A4 adjustable angle literature holders included
- 450mm dia. steel dome base supplied as standard
- Graphic fixing kit included
- Optional ballast weight\*
- Additional Linear accessories are available

Model	Code	(h) x (w) x (d) mm
Graphic and literature post	LK026-001	2060 x 523 x 450 mm
*Ballast weight	LN900 (9kg)	
Steel literature holder (A4)	LN112-C	
Base bag	AB910	
Pole bag	AB293	

Rigid graphic panel



Reclining documents

## Cascade



- Lightweight polymer collapsible based literature holder
- Four A4 pockets

Model	Code	(h) x (w) x (d) mm
Cascade	AS320	1480 x 265 x 310 mm



Complete with carry bag

## Zed-Up Lite



- Double-sided acrylic and anodised aluminium collapsible shelves
- Available in three sizes
- Complete with heavy duty hard case

Model	Code	(h) x (w) x (d) mm
A5 (7 shelves)	AS315-002	1300 x 194 x 284 mm
A4 (6 shelves)	AS318-002	1460 x 256 x 370 mm
A3 (6 shelves)	AS319-002	1420 x 470 x 370 mm



Hard case included



# Counters

## Accessories

Designed for a wide variety of uses, our counters are portable and can be used in all your events; they are ideal for your conferences or as a welcoming point for your visitors. We have created a range of counters in various sizes and styles, with fabric or PVC graphics.



### Vector Straight Counter



- Vector aluminium structure with rounded corners
- Graphic panels push into the channels of the profile with an SEG profile
- Counter top and wooden shelf available in four colours: ● ● ○ ●
- Internal shelf included
- Custom sizes available
- Optional carrying bags

Model	Code	↕ (h) x (w) x (d) mm
Vector straight	VSCB	1015 x 1040 x 540 mm
Bag with tube (for counter)	AB120AM	
Shelf and shelf bag	AB914	



Graphic with PVC ring



Optional bag



Assemble with coding system

### Vector Curved Counter



- Vector aluminium structure with rounded corners
- Graphic panels push into the channels of the profile with a SEG profile
- Counter top and wooden shelf available in four colours: ● ● ○ ●
- Internal shelf included
- Custom sizes available
- Optional carrying bags

Model	Code	↕ (h) x (w) x (d) mm
Vector Curved	VCCB	1015 x 1340 x 540 mm
Shelf and shelf bag	AB916	
Kit 2 bags (counter)	AB120AC-KIT	



Sleek rounded edges

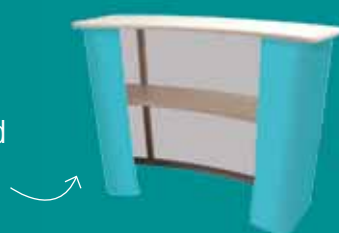

## Formulate Rectangle Counter



- Ø32mm aluminium tubular structure
- Fabric graphic with zip system
- Easy assembly

Model	Code	(h) x (w) x (d) mm
Formulate Rectangle Counter	FMLT-SQA-01	1015 x 800 x 530 mm

Lightweight portable counter



360° visible fabric graphic

## Formulate Large Rectangle Counter



- Ø32mm aluminium tubular structure
- Fabric graphic with zip system
- Black wooden tabletop included
- Supports 50kg load
- Assemble with coded system

Model	Code	(h) x (w) x (d) mm
Formulate Large Rectangle Counter	FMC-SQA-02	1015 x 1880 x 520 mm



Modest curve 

## Linear Lite Counter



- Anodised aluminium counter for 3-5 mm thick PVC foamed board graphics (not included, can be quoted for)
- Suitable for magnetic or infill panels
- Tool free and easy assembly thanks to twist and lock system
- Thermoformed wooden tabletop and base available in four colours: ● ● ○ ●
- Optional internal shelf available on request

Model	Code	↗ (h) x (w) x (d) mm
Linear Lite	LK038	1040 x 915 x 405 mm
Carry Bag	AB112A	
Case	AC311	
Internal Shelf	PK8-S1S	
A4 Steel Literature Holder	LN112-004	
A5 Steel Literature Holder	LN112-005	

## Linear Curved Counter



- Anodised aluminium counter for 3-5 mm thick PVC foamed board graphics (not included, can be quoted for)
- Suitable for magnetic or infill panels
- Tool free and easy assembly thanks to twist and lock system
- Available in 30° and 45° radius
- Thermoformed wooden tabletop and base available in four colours ● ● ○ ●
- Optional magnetic tape or hook and loop
- Optional internal shelf available on request

Model	Code	↗ (h) x (w) x (d) mm
Standard 30°	LK028-001	1010 x 1025 x 546 mm
Standard 45°	LK028-003	1010 x 1515 x 607 mm
Pro 30°	LK028-002	1010 x 1025 x 546 mm
Pro 45°	LK028-004	1010 x 1515 x 607 mm
Carry bag for 30°	AB112A	
Carry bag for 45°	AB221	
Internal shelf	PK8-S1S	

Top Shelf Acrylic (Pro version) 



Table top available in four colours 



## Linear Straight Counter



- Anodised aluminium counter for 3-5 mm thick PVC foamed board graphics (not included, can be quoted for)
- Suitable for magnetic or infill panels
- Tool free and easy assembly thanks to twist and lock system
- Thermoformed wooden tabletop and base available in four colours: ● ● ○ ●
- Optional internal shelf available on request

Model	Code	↗ (h) x (w) x (d) mm
1000 mm (l)	LK029-001	1010 x 1000 x 500 mm
2000 mm (l)	LK029-002	1010 x 2000 x 500 mm
Linear Counter Bag 1000mm	AB112A	
Linear Counter Bag 2000mm	AB222	
Internal Shelf	PK8-S1S	

# Cases Accessories

We know how important it is to provide you with practical, lightweight containers to transport your frames and graphics. Our range of bags, cases and crates will meet your specific requirements.



Wheeled for easy transportation



Zipped opening

Up to 115l capacity



## Carry Bags



- Nylon bag with wheels
- Rigid interior
- Capacity up to 115 litres per bag

Model	Code	(h) x (w) x (d) mm
1370 mm	AB-LINEAR	1370 x 290 x 290 mm

Reinforced carrying handle

Stacks up to three



Up to 300l capacity



Stack up to two boxes

## NEW Flight Case



- Plywood box
- Interior dimensions: 330 x 1321 x 421 mm
- Two spring-loaded handles
- Set of four castors including two with brakes
- Two sliding recessed clasps
- Max weight supported: 100 kgs
- Available colours: ○ ● ● ●

Model	Code	(h) x (w) x (d) mm
Flight case with lock	AC510-1X1-WA	360 x 1345 x 445 mm
Two flight case with lock	AC510-2X1-WA	720 x 1345 x 445 mm
Three flight case with lock	AC510-3X1-WA	1080 x 1345 x 445 mm



Reinforced corners



Secure lock

## Transport Container



- Wooden box on wheels with carrying handle, straps (5m) and lid
- Set of four castors including two with brakes
- Max weight supported: 150 kgs per box

Model	Code	(h) x (w) x (d) mm
<b>Container with wheels</b>		
1350 mm	LNPC-1350-01	1350 x 400 x 300 mm
2580 mm	LNPC-2580-01	2580 x 400 x 300 mm
<b>Stackable container</b>		
1350 mm	LNPC-1350	1350 x 400 x 300 mm
2580 mm	LNPC-2580	2580 x 400 x 300 mm



Reinforced carrying handle



Wheels with brakes



# Lighting Accessories

Focus on the items you want to highlight.

Modular solutions come alive with lighting. Our full range of lighting includes halogen spotlights, LED spotlights and spotlights.

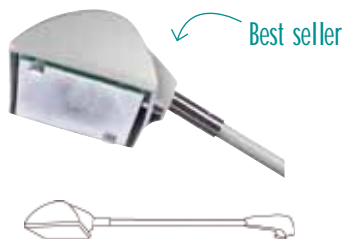

## Powerspot 1000



- Powerful 120 Watt halogen spotlight for umbrella stands, Vector and Linear (optional fasteners)
- Available in black and silver
- Fixed arm of 250mm with 360° swivel head
- UK plug convertible to EU plug
- Universal mounting kit included

Model	Code
Black	PS1000-203E
Grey	PS1000-103E
Bag for two lights	AB101

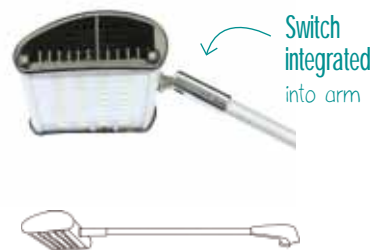

## Powerspot 1060 LED



- Silver LED spotlight with a power of 100W and a low consumption of 20 Watt
- Fixed right arm with 360° swivel head
- Built-in switch
- UK plug convertible to EU plug
- Universal mounting kit included

Model	Code
Powerspot 1060 LED	PS1060S
Bag for two lights	AB101

## Perfect for illuminating large exhibition areas!

LED spots offer a power of 80 Watt while consuming little as 12Watt, (that is 1200lm). Available as a single light (spot, fixing and linking cable) or double kit (two spots, fixings, cables and a transformer), they connect in series up to five spots on the same transformer. The moulded mounting bracket is compatible for Linear and Vector (universal mounting optional for other systems, except for LED Exhibition Spotlight) - UK plug convertible to EU plug.

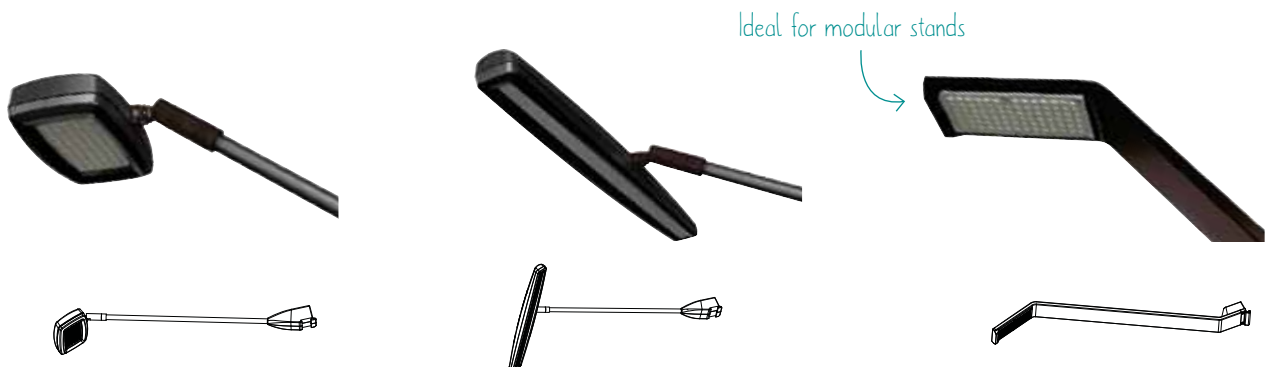

## LED Floodlight



Model	Code
Single light	LED-FLOOD-ARM-B
Double Kit	LED-FLOOD-ARM-BDLK
Transformer	LED-ARM-TRANS

## LED Strip Light



Model	Code
Single light	LED-STRIP-ARM-B
Double Kit	LED-STRIP-ARM-BDLK
Transformer	LED-ARM-TRANS

## LED Exhibition Light



Model	Code
Single light	LED-EXHIB-ARM-B
Double Kit	LED-EXHIB-ARM-BDLK
Transformer	LED-ARM-TRANS



## LED Flood Lighting



- 85-265 voltage, 42 watt LED Flood light (equivalent to 400 watt halogen)
- Available in white and RGB
- Remote control only with RGB version
- Angles to 120°
- For indoor use only

Model	Code	↗ (h) x (w) x (d) mm
White	LED-FLOOD-40W	188 x 240 x 130 mm
RGB	LED-FLOOD-40W-RGB	188 x 240 x 130 mm



## Mini LED Floodlight



- 10 watt LED flood light
- Available in white and RGB
- Remote control only with RGB version
- Angles to 120°
- For indoor use only

Model	Code	↗ (h) x (w) x (d) mm
White	LED-FLOOD-10W	86 x 114 x 101 mm
RGB	LED-FLOOD-10W-RGB	86 x 114 x 101 mm



## Colour Blast Accent LED



- 85-265 voltage, 13 watt LED blast light
- Available in cool white or RGB spectrum flashing pattern
- Face plate is flush with base and angles to 60°
- For indoor use only

Model	Code	↗ (h) x (w) x (d) mm
White	LED-CW-BLAST	270 x 205 x 120 mm
RGB	LED-RGB-BLAST	270 x 205 x 120 mm

## NEW LED Lighting Kit



- Wide range of widths to suit your
- LED lighting requirements from 0.85m up to 2.5m
- Add up to four spare strips in series to further extend your lighting
- Choose from RGB or cool white
- Remote control only with RGB version

Model	Code
<b>Flexi Kits</b>	
Flexi Kit 0.85m RGB	LED-FK-85R
Flexi Kit 0.85m White	LED-FK-85W
Flexi Kit 1.5m RGB	LED-FK-150R
Flexi Kit 1.5m White	LED-FK-150W
<b>Spare Strips</b>	
0.85m RGB	LED-SS-85R
0.85m White	LED-SS-85W
1.5m RGB	LED-SS-150R
1.5m White	LED-SS-150W
2.0m RGB	LED-SS-200R
2.5m RGB	LED-SS-250R
2.5m White	LED-SS-250W

## Flexi Kits



## Spare Strips



Economical solution for lighting your counters



## Round Spot



- 5 Watt Low Power LED Spot

Model	Code	↕ (h) x (w) x (d) mm
Round Spot	LED-5W-120D	Ø120 mm



## Linear Mount



Model	Code
Linear Mount	US-LINEAR



## Vector Mount



Model	Code
Vector Mount	VLF



## Universal Fixing Kit



- Included with PS1000/PS1060
- Includes: Clamp ring, Pop-up plate, Universal plate, Screwdriver
- Enables lights to be fitted to banners, Pop-ups, modular panel systems and Arena 4 Gantry

Model	Code
Universal fixing kit	US901-C

## Convert your UK plug to EU version

①



②

Unscrew



③

Lift the top



④

Pull the plug out



## Recommendations for use

Products \ Spots	Formulate	Linear	Vector	Arena
PS1000	●	●	●	●
PS LED 1060		●	●	
Spot LED Flood	●	●	●	
Spot LED Strip	●	●	●	
Spot LED Exhibition	●	●	●	

- Linear Fitting US-LINEAR Not supplied
- Fitting integrated with the spot
- Vector Fitting VLF not included
- Kit US901-C not supplied



Large stock of aluminium profiles and tubes

## Manufactured in the UK for a high quality end product

The creation of Vector, Linear and Formulate modular displays requires design ingenuity and precision engineering.

All stages of design and manufacturing are carried out locally by our own teams at our production facility. This proximity allows you to benefit from the expertise of a partner who manages your project entirely, from its concept to its delivery.



Each structure produced is pre-assembled and tested before shipping and accompanied by full instructions. For ease of assembly, each module and section has a simple coded system.

With a wide selection of different modular solutions and configurations, you are sure to find the display solution that will meet your needs.





Standard and custom-made solutions ↷

## Perfect vibrant print for all Modular Displays

With the latest printing innovations our large-format printers can create vibrant graphics that enhance branding communication to set you apart from the competition.



To guarantee quality graphics that are adaptable for all uses, we have selected a wide choice of print media.



The diversity of materials allows us to meet your requirements in the shortest possible time.

Before shipping, all our graphics are completed by our highly skilled experts of our Finishing Team who control the quality and great finish of each and every order.



## Advice and technical support

Wall frame, free-standing frame or exhibition stand, modular solutions offer you maximum visual impact and versatile designs that adapt to all types of environments.

With a wide range of standard and custom-made displays, you are sure to find the configuration that meets your needs and budget.

Our CAD department is at your disposal to guide you in the choice and design of the modular solution best suited to your project.

Our designers will advise you and offer fully customised and highly creative configurations.

Request 3D visual  
of your project

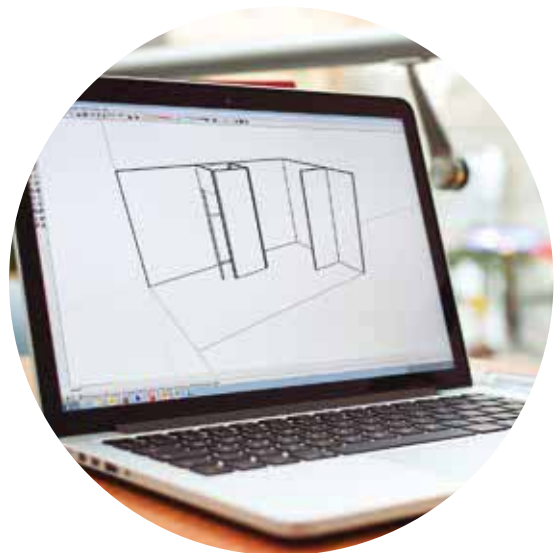
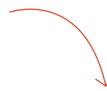

You benefit from the expertise of a local partner who manages your project entirely, from its design to its delivery.





# Our Services

+ Find the modular configurations of this catalogue and many more on our dedicated website:  
[www.modular-brochure.co.uk](http://www.modular-brochure.co.uk)

+ Our CAD department is here to help. Ask for a 3D rendering of your future project to give you an overview of the final result.



+ Demo videos and installation explanations are also available.

+ In order to better understand your project and enable us to bring you the best solutions, information sheets are available too - just ask your local dealer.



Micro site available at any time



# MODULAR

Creative stand solutions for unique brands

